

KENWOOD

MDX-G2

MINIDISC PERSONAL STEREO SYSTEM

INSTRUCTION MANUAL



MDLP

Before applying power

⚠ Caution : Read this page carefully to ensure safe operation.

Units are designed for operation as follows.

U.S.A. and Canada AC 120 V only
Australia AC 240 V only
Europe and U.K. AC 230 V only

China and Russia AC 220 V only
Other countries AC 110 - 120 / 220 - 240 V
switchable

For the United Kingdom

Factory fitted moulded mains plug

1. The mains plug contains a fuse. For replacement, use only a 13-Amp ASTA-approved (BS1362) fuse.
2. The fuse cover must be refitted when replacing the fuse in the moulded plug.
3. Do not cut off the mains plug from this equipment. If the plug fitted is not suitable for the power points in your home or the cable is too short to reach a power point, then obtain an appropriate safety approved extension lead or adapter, or consult your dealer.

If nonetheless the mains plug is cut off, remove the fuse and dispose of the plug immediately, to avoid a possible shock hazard by inadvertent connection to the mains supply.





IMPORTANT: The wires in the mains lead are coloured in accordance with the following code:

Blue : Neutral
Brown : Live

Do not connect those leads to the earth terminal of a three-pin plug.

Safety precautions

WARNING : TO PREVENT FIRE OR ELECTRIC SHOCK, DO NOT EXPOSE THIS APPLIANCE TO RAIN OR MOISTURE.

	CAUTION RISK OF ELECTRIC SHOCK DO NOT OPEN		CAUTION: TO REDUCE THE RISK OF ELECTRIC SHOCK, DO NOT REMOVE COVER (OR BACK). NO USER-SERVICEABLE PARTS INSIDE. REFER SERVICING TO QUALIFIED SERVICE PERSONNEL.
	THE LIGHTNING FLASH WITH ARROWHEAD SYMBOL, WITHIN AN EQUILATERAL TRIANGLE, IS INTENDED TO ALERT THE USER TO THE PRESENCE OF UNINSULATED "DANGEROUS VOLTAGE" WITHIN THE PRODUCT'S ENCLOSURE THAT MAY BE OF SUFFICIENT MAGNITUDE TO CONSTITUTE A RISK OF ELECTRIC SHOCK TO PERSONS.		
	THE EXCLAMATION POINT WITHIN AN EQUILATERAL TRIANGLE IS INTENDED TO ALERT THE USER TO THE PRESENCE OF IMPORTANT OPERATING AND MAINTENANCE (SERVICING) INSTRUCTIONS IN THE LITERATURE ACCOMPANYING THE APPLIANCE.		

The marking of products using lasers (Except for some areas)

**CLASS 1
LASER PRODUCT**



CAUTION
INVISIBLE LASER RADIATION
WHEN OPEN. AVOID EXPOSURE
TO BEAM.

The marking is located on the rear panel and says this product has been classified as Class 1. It means that there is no danger of hazardous radiation outside the product

Inside this laser product, laser diodes classified as Class 3A and 3B laser radiation are contained as alerted by the internal caution label shown above. To avoid exposure to laser beams, do not open the cover.

Contents

Caution : Read the pages marked  carefully to ensure safe operation.

 Before applying power	2
 Safety precautions	2

Preparation section

System connection	4-6
Unpacking	4
Loading batteries in the remote control unit	4
Connecting the accessories	5
Connecting other components	6
Adjusting the current time	7
Presetting radio stations	8-9
Presetting stations automatically	8
Presetting stations manually	9

Basic section

Playback of CD	10
Playback of MD	12
Receiving broadcast stations	14
Recording CD onto MD (MD O.T.E.)	16
Playing audio input from AUX component	18

Application section

Displayed information	19-20
Viewing the CD information	19
Viewing the MD information	20
Adjusting the tone	21
Enhancement of bass and treble (EX.BASS/LOUDNESS)	21
Fine adjustment of bass and treble (TONE)	21
Adjusting the AUX input level	22
Playing CD or MD tracks in the desired sequence (PGM)	23

Repeating a CD or MD (REPEAT)	24
Playing a CD or MD in random (RANDOM)	24
Stereo LP modes	25
Setting the recording mode	26
High-speed recording of all CD tracks onto an MD	27
Recording onto MD	29
Recording CD tracks onto MD in desired sequence	30
Recording only the first track of CD (BEST HITS)	31
Editing the MD titles	32-34
Assigning a title to a disc or track	32
Title editing character list	34
Moving several tracks at a time	35
Combining tracks	37
Dividing a track	39
Erasing several tracks at a time	41
Canceling editing	42
Waking up to the timer playback (O.T.T.)	43
Program timer	45-48
Timer playback using program timer	45
Timer recording using program timer	47
Sleep timer (SLEEP)	49
Auto power save (A.P.S.)	49

Knowledge section

Important items	50
In case of difficulty	53
Display message list	56
Specifications	57
Controls and indicators	58

System connection

Unpacking

Unpack the unit carefully and make sure that all the accessories are present.

Power cord (1)



AM loop antenna (1)

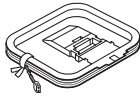

Remote control unit (1)



Batteries (R6/AA)
for remote (2)

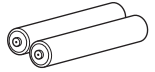

If any accessories are missing, or if the unit is damaged or fails to operate, notify your dealer immediately. If the unit was shipped to you directly, notify your shipper immediately. Kenwood recommends that you retain the original carton and packing materials in case you need to move or ship the unit in the future.

Keep this manual handy for future reference.

Loading batteries in the remote control unit

(1) Remove the battery compartment cover of the remote.

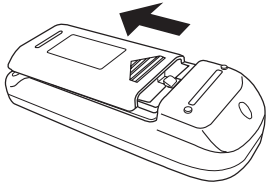

(2) Insert two R6("AA")-size batteries following the polarity indications.

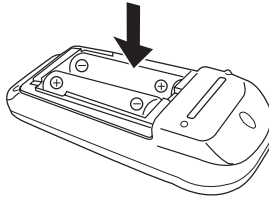

(3) Attach the battery compartment cover.

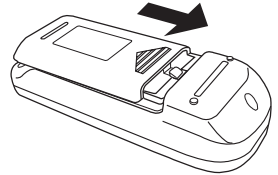

- The provided batteries are intended for use in operation checking, and their service life may be short.
- When the remote-controllable distance becomes short, replace both of the batteries with new ones.
- If the remote sensor on the main unit's front panel is exposed to direct sunlight or the light of a high-frequency fluorescent lamp (inverter type, etc.), malfunction may occur. In such a case, change the installation position to avoid malfunction.
- When pressing more than one remote control keys successively, press each key securely by leaving an interval of 1 second or more between keys.
- The standard remote-control range is within approximately 6 meters from the main unit's front panel. Be sure to point the remote to the remote sensor on the front panel.

remote sensor

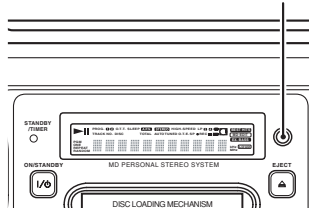

Connecting the accessories

FM rod antenna

Extend the FM antenna and orient it to obtain the best receiving condition possible.

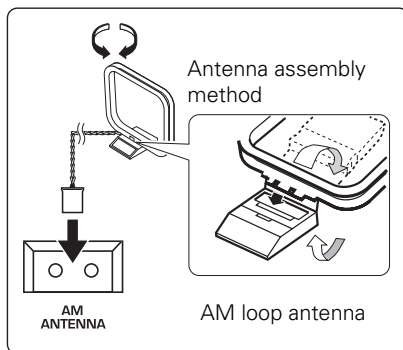
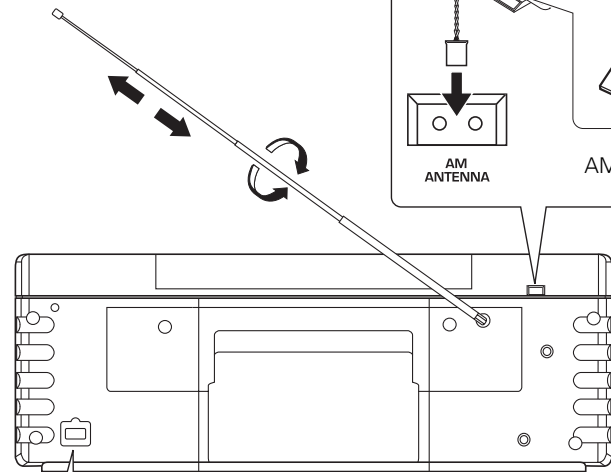

The provided antenna has been designed for indoor use. Place it in a position as apart as possible from a TV and power cords and orient it to obtain the best receiving condition.

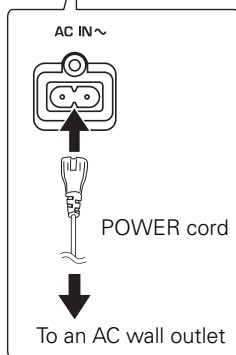

- When removing the power cord connection, unplug the power plug of the wall outlet first.

POINT

- Be sure to insert each connection cord securely. If a cord is plugged in incompletely, audio may not be output or noise may be generated.
- Before connecting or disconnecting any connection cord, be sure to first unplug the power cord from the wall power outlet.
- Do not install the speakers near a TV set. Otherwise, color irregularities due to magnetism may be observed on the TV screen.
- Be sure to put the unit to the STANDBY mode (page 59) before unplugging the power cord.

Continued on next page →

Connecting other components

AUX (auxiliary) component

An additional MD player, cassette deck or analog turntable with built-in equalizer (such as the P-110) which are available separately can optionally be connected to the system using an audio cable with stereo mini-plugs (separately available).

- The AUX IN terminals are input jacks. An AUX component for use in recording cannot be connected to the system.
- When recording an AUX component, also read the instruction manual of the component.
- When an analog turntable is connected and located in proximity of the system, howling noise may interfere with the system when the listening volume is increased. In this case, install the analog turntable farther apart from the system.
- The input level from the AUX component can be adjusted on this system. (page 22)

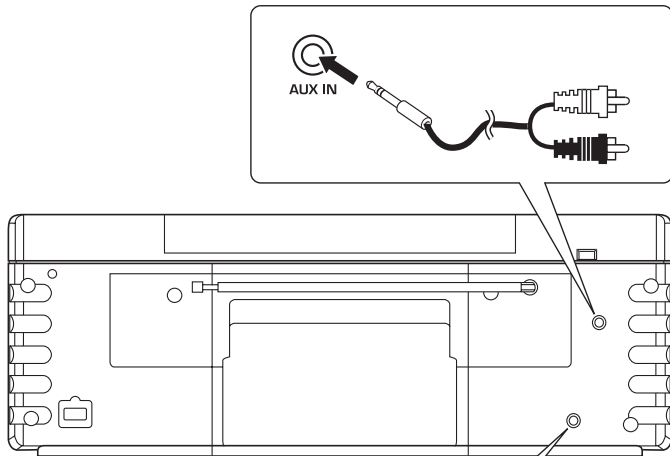

Headphones

Plug the optional headphones equipped with stereo mini-plugs.

- When listening audio through speakers, unplug the headphones from the PHONES jack.

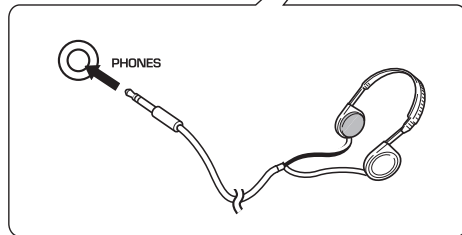

CAUTION

Be sure to adhere to the following, or proper ventilation will be blocked causing damage or fire hazard.

- Do not place any objects impairing heat radiation onto the top of the unit.
- Leave a space around the unit (from the largest outside dimension including projection) equal or greater than, shown below.

Back panel : 10 cm

Adjusting the current time

To use the timer function, it is required to set the built-in clock of the unit to the correct time. The clock shows the time of day in 12-hour system.

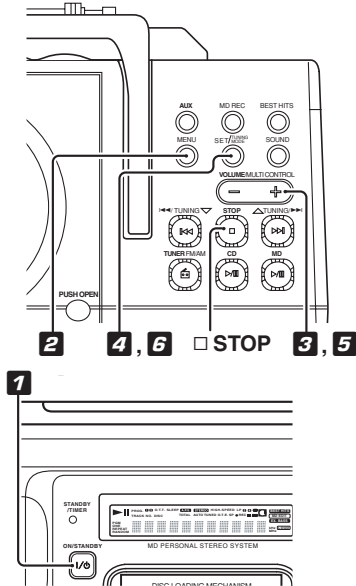

Example : Adjustment to 8:07am

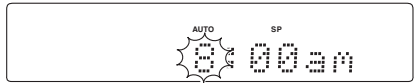

12 o'clock during the day is displayed as "12:00pm" and 12 o'clock midnight is displayed as "12:00am".

4 Press the SET/TUNING MODE key.

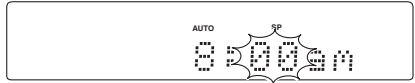

5 Press the VOLUME/MULTI CONTROL keys to input the figure of minute.

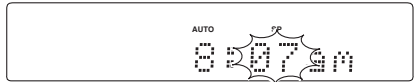

6 Press the SET/TUNING MODE key.



Main unit only

1 Press the ON/STANDBY | / ⏻ key to switch the power on.

2 Press and hold the MENU key for more than 2 seconds.



3 Press the VOLUME/MULTI CONTROL keys to select the hour figure.

To check the time of day :

Press the □STOP key while the unit is in the STANDBY mode (page 59).

POINT

- After a power failure, when the power cord is unplugged and plugged again or when the STANDBY/TIMER indicator blinks in green, the current time should be adjusted again.
- In step 2, accurate time adjustment is possible by pressing the SET/TUNING MODE key at the same time as a time announcement indicating the 00 second of the minute.

Presetting radio stations

A total of 30 desired stations can be stored in the auto and manual preset memory.

Presetting stations automatically (AUTO PRESET)

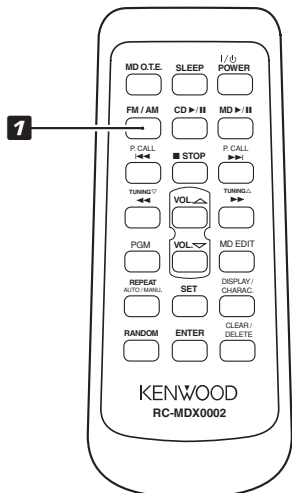

- 1 Press the **TUNER FM/AM** key (or the **FM/AM** key on the remote) so that the “**AM**” or “**FM**” band is selected.

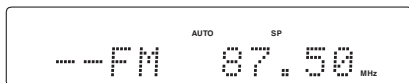

- 2 Press the **MENU** key.
- 3 Press the **VOLUME/MULTI CONTROL** keys to select “**AUTO PRESET**”, then press the **SET/TUNING MODE** key.



The **AUTO PRESET** operation starts and “**AUTO PRESET**” is displayed. **FM** stations are preset first, after which the **AM** stations are preset.

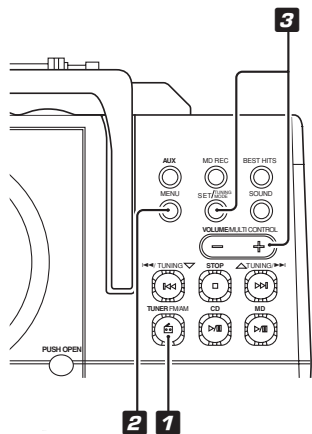

POINT.

- When **AUTO PRESET** is performed, the stations previously preset will be replaced by the newly preset stations.
- In certain regions, the automatically tuned and preset stations may not be received in a favorable condition.

If a desired station cannot be preset by **AUTO PRESET, use **MANUAL PRESET** to preset it. (page 9)**

Presetting stations manually (MANUAL PRESET)

Among the receivable stations, only the desired stations can be received and preset individually.

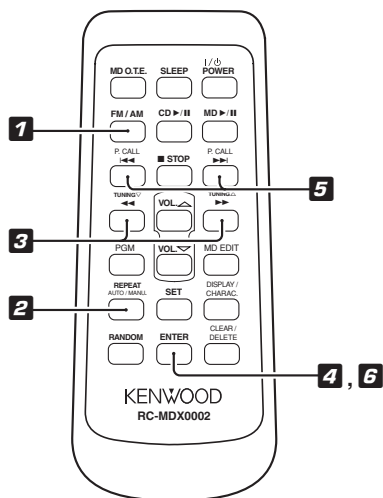

Remote control unit only

- 1 Press the **FM/AM** key so that the "FM" or "AM" band is selected.

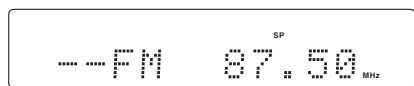

- 2 Press the **REPEAT/AUTO/MANU.** key so that "AUTO" is displayed.

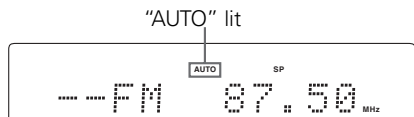

- 3 Press the **◀ TUNING ▽** or **▶ TUNING △** key to tune in the desired station.

- 4 Press the **ENTER** key during reception.

- 5 While "--" is blinking, press the **◀ P.CALL** or **▶ P.CALL** key repeatedly to select the desired preset number.

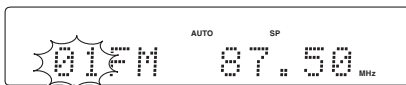

Press and hold the **◀ P.CALL** or **▶ P.CALL** key to skip preset numbers.

- 6 Press the **ENTER** key.



To preset another station :

Repeat steps **1** to **6**.

To preset a station with weak radio wave :

If the radio waves are weak, switch to manual tuning mode. In step **2**, select the manual tuning mode by pressing the **REPEAT/AUTO/MANU.** key so that "AUTO" disappears.



- When a station is preset in a preset number which stores a previously preset station, the newly preset information overwrites the previously preset information.

Playback of CD

To play a CD.

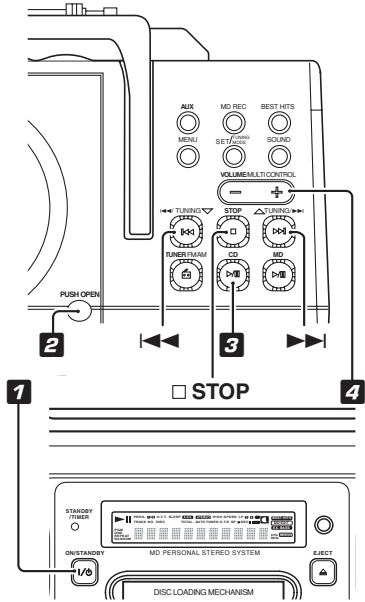
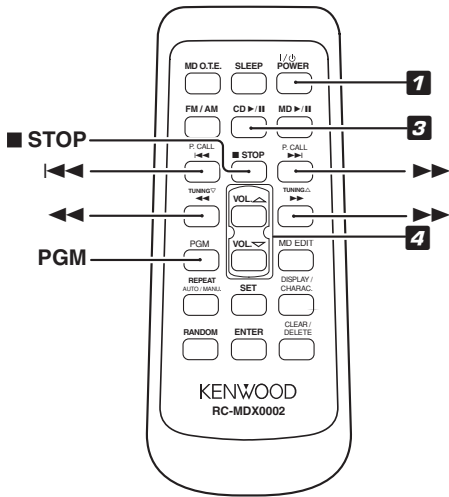

1 Press the **ON/STANDBY** I/O key (or I/O **POWER** key on the remote) to switch the power on.

2 Insert a CD.

The CD should be placed horizontally on the tray to prevent malfunction. Do not place it obliquely.

- (1) Open the CD door by pressing the area marked "PUSH OPEN" on the CD door.
- (2) Place a CD.
- (3) Close the CD door by pressing the area marked "PUSH OPEN" on the CD door.

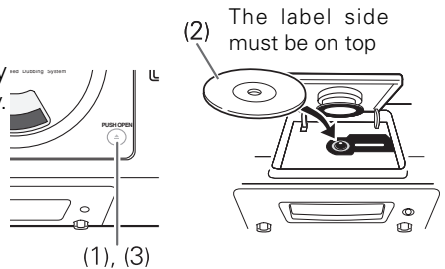

3 Press the **CD** \blacktriangleright / **||** key.

Play indicator

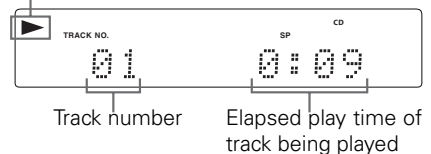

- 4** Press the **VOLUME/MULTI CONTROL** keys to adjust the listening volume. The volume can also be adjusted using the **VOL. Δ / ▽** keys on the remote.

Operation of keys

Purpose	Operation
To stop playback	Press the ■STOP key.
To let playback pause	Press the CD ►/ key. Press it again to resume playback.
To skip a track	Press the ►► key to skip to the next track. Press the ◀◀ key quickly twice to skip to the previous track.
To fast forward audio	Press and hold the ►► key on the remote during playback, and release the key at the position you want to restart normal playback.
To fast reverse audio	Press and hold the ◀◀ key on the remote during playback, and release the key at the position you want to restart normal playback.
To start playback from the desired track	Select the desired track number using the skip ►►/◀◀ keys. If "PGM" is lit, switch it off during stop mode by pressing the PGM key on the remote.

To take out the CD :

Stop playback by pressing the ■ STOP key, then press the area marked "PUSH OPEN" on the CD door to open it.

POINT

- Do not force open or close the CD door, for this will lead to malfunction.
- When a CD has been inserted while the power is OFF, simply pressing the CD ►/|| key in the STANDBY mode (page 59) turns the power ON and starts playback. (One-touch operation)
- For the types of CDs that can be played on this unit, see "Discs which can be played with this unit" (page 50).

Playback of MD

To play an MD.

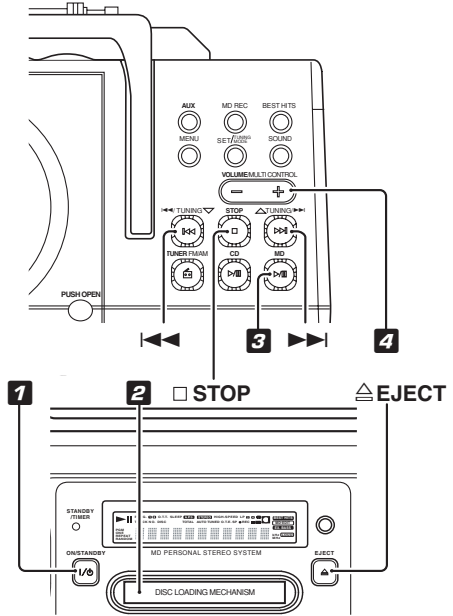
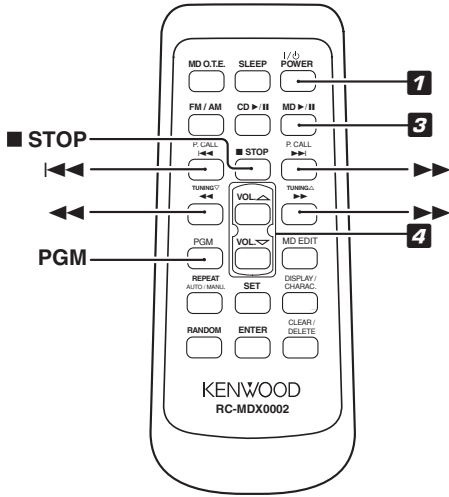

1 Press the **ON/STANDBY** I/⏻ key (or I/⏻ **POWER** key on the remote) to switch the power on.

2 Insert an MD.

Insert an MD into the insertion slot of the main unit.

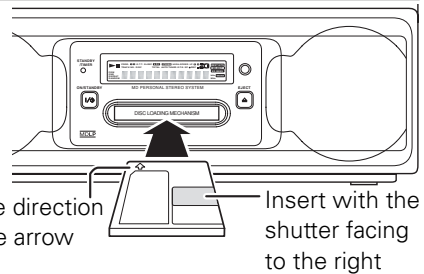

3 Press the **MD ▶/||** key.

Play indicator

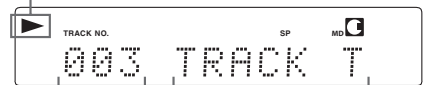

Track number

Track title



Elapsed play time of track being played

- 4** Press the **VOLUME/MULTI CONTROL** keys to adjust the listening volume. The volume can also be adjusted using the **VOL. Δ / ▽** keys on the remote.

Operation of keys

Purpose	Operation
To stop playback	Press the ■STOP key.
To let playback pause	Press the MD ▶/ key. Press it again to resume playback.
To skip a track	Press the ▶▶I key to skip to the next track. Press the I◀◀ key quickly twice to skip to the previous track.
To fast forward audio	Press and hold the ▶▶ key on the remote during playback, and release the key at the position you want to restart normal playback.
To fast reverse audio	Press and hold the ◀◀ key on the remote during playback, and release the key at the position you want to restart normal playback.
To start playback from the desired track	Select the desired track number using the skip ▶▶I / I◀◀ keys. If "PGM" is lit, switch it off during stop mode by pressing the PGM key on the remote.

To take out an MD :

Stop playback by pressing the **■ STOP** key, then press the **△EJECT** key.

MD play mode indicators :

Each track in the MD is played in the similar mode as when it was recorded. When an MD starts playing, the current play mode is indicated by one of the play mode indicators.

SP : Track recorded in standard stereo mode (using an MD recorder without the MDLP* mode compatibility). Play mode

LP2 : Track recorded in the stereo LP2 mode.

LP4 : Track recorded in the stereo LP4 mode.

* Marking "MDLP" is indicated on an MD recorder or player compatible with the stereo LP2 (LP4) mode based on ATRAC3 which is a new audio compression system in compliance with the MD standard, or on an MD medium recorded using ATRAC3 (with a playback-only MD).



POINT

- An MD cannot be inserted or ejected while in STANDBY mode. Do not force insert an MD when in STANDBY mode (page 59), for this will lead to malfunction.
- When an MD is inside the unit while the power is OFF, simply pressing the **MD ▶/||** key in STANDBY mode (page 59) switches the power ON and starts playback. (One-touch operation)
- If the MD recording contains title information, the titles of the disc or tracks recorded in the MD are displayed automatically.

Receiving broadcast stations

Previously stored (preset) radio stations can be tuned with one-touch operation.

For the preset procedure, see "Presetting radio stations" (page 8 to 9).

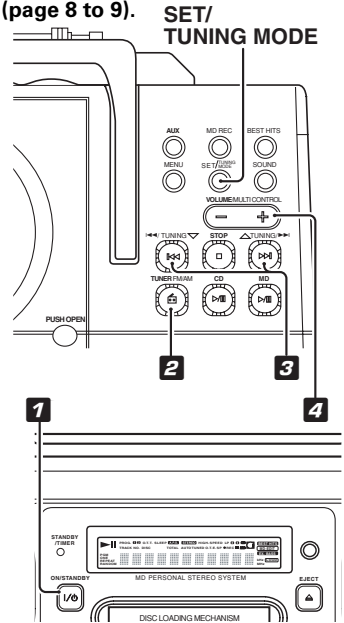
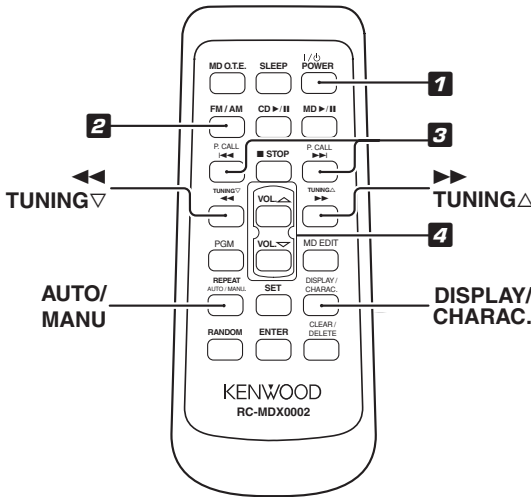

1 Press the **ON/STANDBY** I/O key (or **I/O POWER** key on the remote control) to switch the power on.

2 Press the **TUNER FM/AM** key (or the **FM/AM** key on the remote).

3 Press the $\blacktriangleleft\blacktriangleleft$ / **TUNING** ∇ or $\blacktriangleright\blacktriangleright$ / **TUNING** Δ key on the main unit (or the $\blacktriangleleft\blacktriangleleft$ / **P.CALL** or $\blacktriangleright\blacktriangleright$ / **P.CALL** key on the remote) to select a preset station.

Each press of the key switches the preset station in sequence.

4 Press the **VOLUME/MULTI CONTROL** keys to adjust the listening volume. The volume can also be adjusted using the **VOL.** Δ / ∇ keys on the remote.

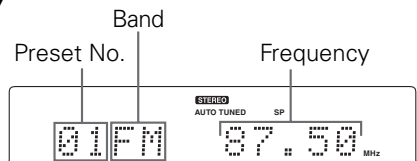

Receiving non-preset broadcast stations

A radio station can be tuned either by auto tuning or manual tuning according to the current reception condition.

- Press the SET/TUNING MODE key on the main unit (or the REPEAT/AUTO/MANU. key on the remote) to select AUTO or MANUAL tuning mode.

When "AUTO" is lit : Indicates the auto mode (stereo reception) which is suitable when the receiving condition is good.

When "AUTO" is not lit : Indicates the manual mode (monaural reception) which is suitable when the receiving condition is poor.

- Usually leave "AUTO lit (auto tuning mode, stereo reception).

- "AUTO" or "MANUAL" is displayed when you press SET/TUNING MODE key, then press the ◀◀/TUNING▽ or △TUNING/▶▶ key on the main unit to receive the desired station.

Pressing the ◀◀ TUNING▽ or ▶▶ TUNING△ key on the remote will enable you to select the desired station.

Auto tuning : Each press of the key tunes the next station automatically.

Manual tuning : Press and hold the key until the next station is tuned.

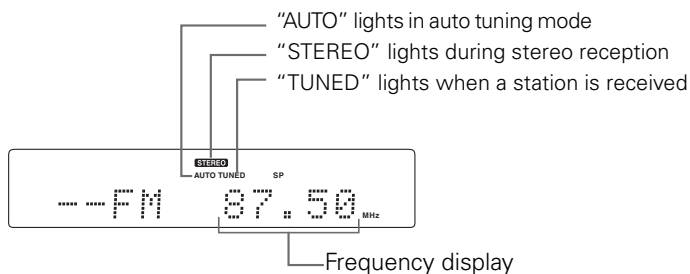

POINT

- When the unit is in STANDBY mode (page 59), simply pressing the TUNER FM/AM key (or the FM/AM key on the remote) switches the power ON and radio reception starts automatically. (One-touch operation)
- During tuning, pressing and holding the ◀◀/TUNING▽ or △TUNING/▶▶ key on the main unit (or the ◀◀ TUNING▽ or ▶▶ TUNING△ key on the remote) makes it possible to skip undesired stations that may be received before the target station.

Recording CD onto MD (MD O.T.E.)

The MD O.T.E. (One-Touch Edit) function makes it possible to record all tracks in a CD on an MD with a one-touch operation (All-track recording). It is also capable of recording the currently played CD track on an MD with a one-touch operation (Single-track recording).

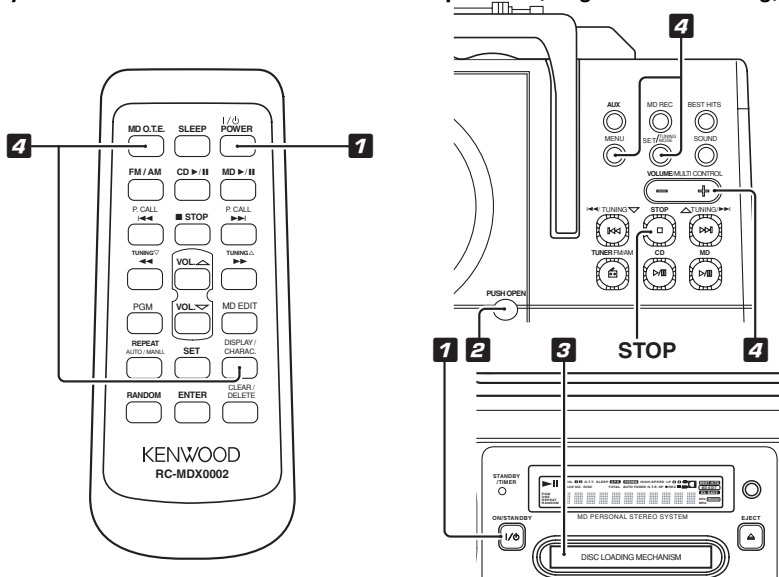

1 Press the ON/STANDBY I/O key (or I/O POWER key on the remote control) to switch the power on.

2 Insert a CD.

The CD should be placed horizontally on the tray to prevent malfunction. Do not place it obliquely.

- (1) Open the CD door by pressing the area marked "PUSH OPEN" on the CD door.
- (2) Place a CD.
- (3) Close the CD door by pressing the area marked "PUSH OPEN" on the CD door.

If the CD is already playing, press the ■ STOP key to stop playback.

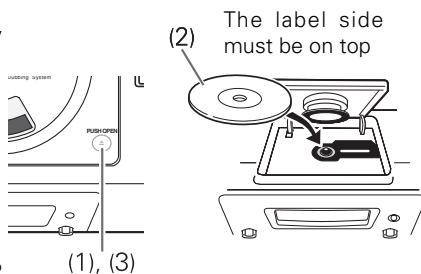

3 Insert a recordable MD.

Insert an MD into the insertion slot of the main unit.

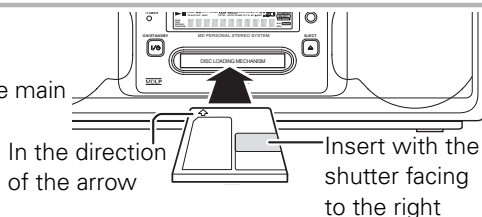

4 Press the MD O.T.E. key on the remote.

If you are operating the main unit :

- (1) Press the MENU key.
- (2) Press the VOLUME/MULTI CONTROL keys to select "MD O.T.E. ?"; then press the SET/TUNING MODE key.
- (3) Pressing the DISPLAY/CHARAC. key on the remote will switch the displayed information.

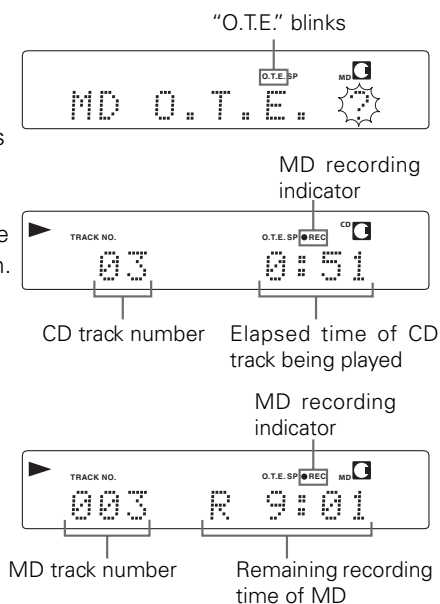

Recording the CD track being played (Single-track recording)

- (1) Play the CD track to be recorded.
- (2) Press the MD O.T.E. key on the remote.

When you are operating the main unit, see step 4.

Recording starts after returning to the beginning of the current track.

To stop recording in the middle :

Press the ■STOP key.

POINT

- Be careful not to switch the power off or apply shock or vibrations to the system while "MD WRITING" is displayed.
- For the types of MDs that can be recorded on this unit, see "Handling of MD" (page 51)
- It is also possible to record a CD onto an MD at double speed. (page 27 to 28)
- The CD audio is recorded following the settings made with MD REC MODE. (page 26)
- The MD O.T.E. recording is not available if the CD is played in the random mode. Cancel the random mode before proceed to recording. (page 24)
- When recording with high volume, sound skip may occur during MD playback. To avoid this problem, reduce the volume during recording.

Playing audio input from AUX component

The audio from the AUX component can be monitored as follows.

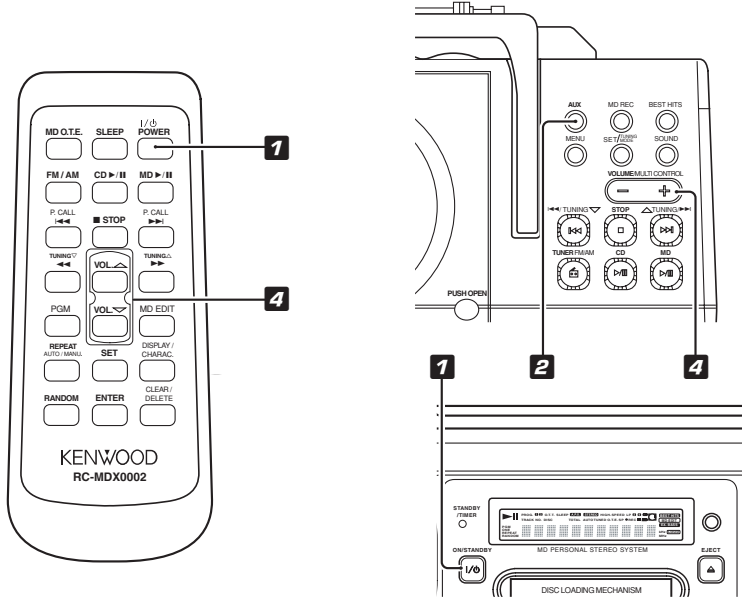

1 Press the **ON/STANDBY** I/O key (or **I/O POWER** key on the remote) to switch the power on.

2 Press the **AUX** key.



3 Play the component connected to the **AUX** input jacks.

4 Press the **VOLUME/MULTI CONTROL** keys to adjust the listening volume. The volume can also be adjusted using the **VOL. Δ / ∇** keys on the remote.

Displayed information

Viewing the CD information

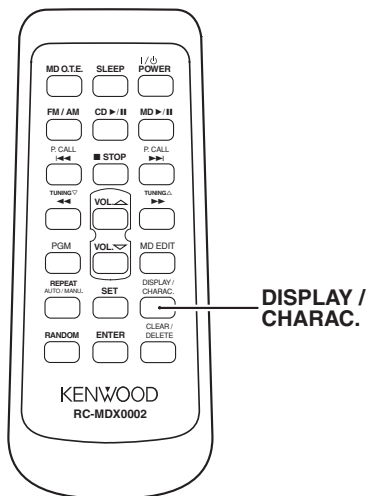

POINT

- Only the information of 1 and 2 is displayed during 1-track repeat or random playback.
- When the displayed time reaches 100 minutes or more, the display shows "--:--"

The displayed information switches each time the DISPLAY/CHARAC. key on the remote is pressed.

1. Elapsed play time of the track being played



2. Remaining play time of the track being played

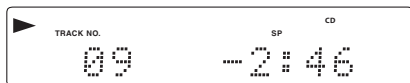

3. Elapsed play time of the disc

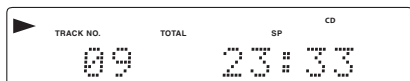

4. Remaining play time of the disc



Continued on next page →

Viewing the MD information

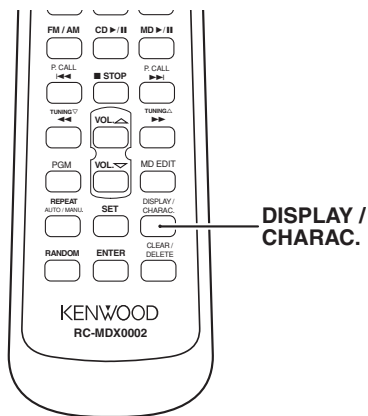

DISPLAY /
CHARAC.

Display in playback

The displayed information switches each time the DISPLAY/CHARAC. key on the remote is pressed.

1. Title of track being played

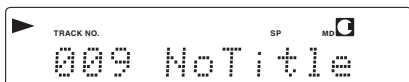

2. Elapsed play time of the track being played



3. Remaining play time of the track being played



4. Elapsed play time of the disc



5. Remaining play time of the disc

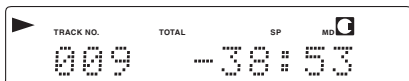

6. Remaining recordable time of the disc

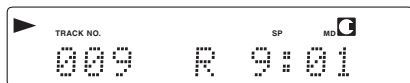

POINT

- Only the information of 1 to 3 is displayed during 1-track repeat or random playback.
- When the displayed time reaches 1000 minutes or more, the display shows "--:--"

Display in recording

The displayed information switches each time the DISPLAY/CHARAC. key on the remote is pressed.

1. Music source being recorded



2. Remaining recordable time of the disc

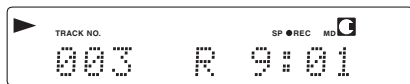

POINT

- "NoTitle" is displayed when the MD does not contain the recording of title data.
- "BLANK DISC" is displayed when the MD does not contain any recording.

Adjusting the tone

Enhancement of bass and treble (EX.BASS / LOUDNESS)

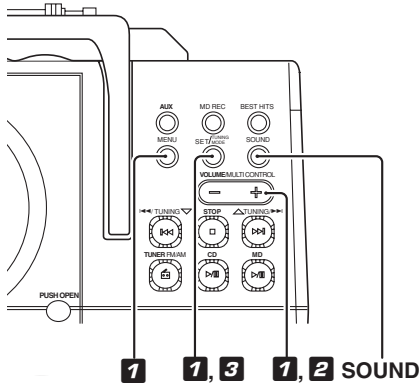

Main unit only

Press the SOUND key repeatedly until the desired tone enhancement is displayed.

“EX. BASS” lit : Enhances the bass tone regardless of the current volume.

“LOUD”(LOUDNESS) lit : Enhances both the bass and treble tones according to the current volume. (Effective during low-volume listening)

Both “EX. BASS” and “LOUD” are off (SOUND MODE OFF) : When the sound mode is switched off.

Display scrolls across when EX. BASS is selected



“EX. BASS” lit

Display scrolls across when LOUDNESS is selected

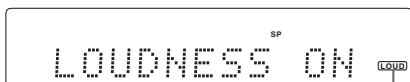

“LOUD” lit

Fine adjustment of bass and treble (TONE)

1 Press the MENU key, then press the VOLUME/MULTI CONTROL keys repeatedly to select “TONE SET?”.

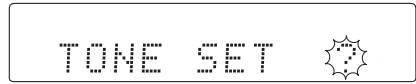

Press the SET/TUNING MODE key until “BASS” or “TREBLE” is displayed.

Display when BASS is selected



“BASS” : Low frequency level adjustment.

“TREBLE” : High frequency level adjustment.

2 Press the VOLUME/MULTI CONTROL keys to the desired level.

The high or low frequency level can be adjusted in the range between -8 and +8.

3 Press the SET/TUNING MODE key.

If the SET/TUNING MODE key is left without being pressed for about 20 seconds after adjustment, the adjusted setting is entered into the memory and overwrites the previous information.

POINT

- The EX. BASS or LOUDNESS mode is canceled if the bass or treble level is adjusted while “EX. BASS” or “LOUD” is lit.
- The effects of EX.BASS and LOUDNESS are not reflected in the recorded audio.

Adjusting the AUX input level

The input level from an AUX component connected to the AUX IN jacks (MD player, analog turntable, VCR, etc.) can be adjusted. It is recommended to adjust it so that the AUX input sounds at a similar volume to the built-in CD and MD.

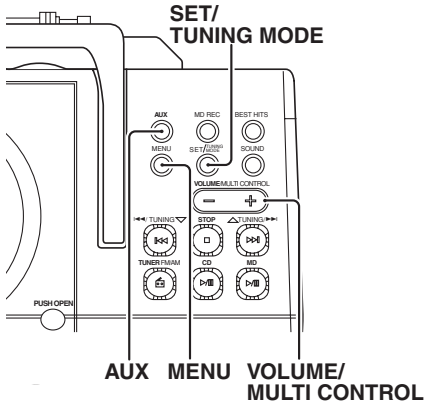

- 5 Press the **VOLUME/MULTI CONTROL** keys to fine adjust the input level, then press the **SET/TUNING MODE** key.

The input level can be adjusted in the range from -5 to +2.



Main unit only

- 1 Press the **AUX** key to select the **AUX input**.
- 2 Play the connected **AUX component** to check the volume.
- 3 Press the **MENU** key.
- 4 Press the **VOLUME/MULTI CONTROL** keys to select "AUX INPUT?", then press the **SET/TUNING MODE** key.



Playing CD or MD tracks in the desired sequence (PGM)

Use the following procedure to program up to 32 desired tracks in a desired order.

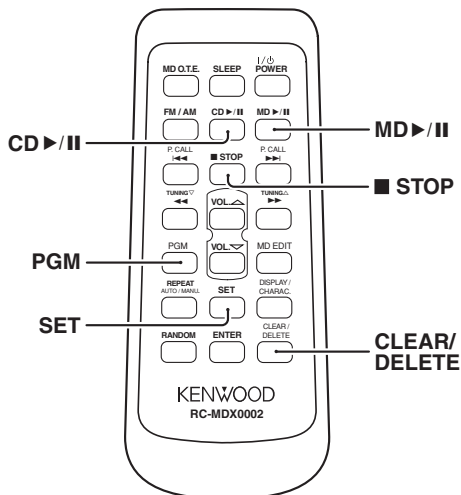

Remote control unit only

1 **CD** : Press the **CD >||** key.
MD : Press the **MD >||** key.

2 Press the **STOP** key.

3 Press the **PGM** key.

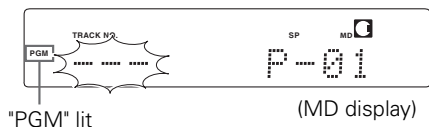

4 Press the **P.CALL** <<< / >>> keys to select the desired track number.

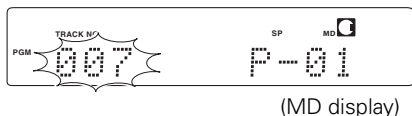

5 Press the **SET** key.

To select other tracks, repeat steps **4** and **5** for each track.

If you made a mistake, press the CLEAR/DELETE key to clear the track number and restart selection.

6 **CD** : Press the **CD >||** key.
MD : Press the **MD >||** key.

To stop program playback :

Press the **STOP** key in playback.

To clear a programmed track :

Press the CLEAR/DELETE key in stop mode. Each press clears the last currently programmed track.

To clear all programmed tracks, press the PGM key.

To cancel program playback :

Press the PGM key during stop mode so that "PGM" is not lit.

POINT.

- When "FULL P-32" is displayed, no more track can be programmed.
- PGM will only function when playback is stopped.
- When PGM key is pressed, "NO PGM" is displayed if there is no programming performed after 20 seconds.

Repeating a CD or MD (REPEAT)

Use the following procedure to play the desired track(s) repeatedly. Repeat playback can be combined with program playback or random playback.

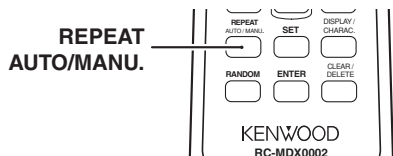

Remote control unit only

Press the REPEAT/AUTO/MANU. key repeatedly so that "ONE" and "REPEAT" or only "REPEAT" light up.

Both "ONE" and "REPEAT" are lit : Only one track will be played repeatedly.

Only "REPEAT" is lit : The tracks in the entire disc will be played repeatedly.



Display when both "ONE" and "REPEAT" are lit

To cancel repeat playback :

Press the REPEAT/AUTO/MANU. key repeatedly until both "ONE" and "REPEAT" are off.

POINT

- When the repeat mode is activated in the program play mode, both "PGM" and "REPEAT" light. When it is activated in the random play mode, both "RANDOM" and "REPEAT" light up. In both cases, all tracks in the program or disc will be played repeatedly.
- Repeat mode can be activated during playback and also when playback is stopped.

24^{EN}

Playing a CD or MD in random (RANDOM)

Use the following procedure to play tracks in random. This will renew the enjoyment of the same disc that you have already played many times.

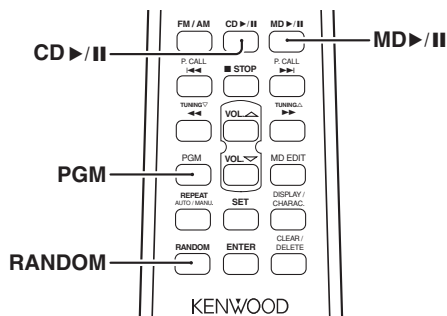

Remote control unit only

- 1 CD : Press the CD >|| key. MD : Press the MD >|| key.**

If the "PGM" indicator is lit, press the ■STOP key to stop playback and press the PGM key on the remote so that the indicator switches off.

- 2 Press ■STOP key, then press RANDOM key so that "RANDOM" is lit.**



"RANDOM" lit

(CD display)

To cancel random playback :

Press the RANDOM key so that "RANDOM" is not lit.

POINT

- Random playback stops after having played all of the tracks on the disc.

Stereo LP modes

The MD recorder of the system is compatible with stereo long play of MD (MDLP compatible equipment).

The available recording modes include stereo, stereo LP2 and stereo LP4 modes, and they can be used with any of the music sources which can be recorded with the MD recorder of the system. It is also possible to accommodate tracks recorded in different recording modes in a single MD.

Be sure to select the recording mode before starting MD recording.

Types of recording modes

Stereo (SP) :

The available recording time is equal to the figure indicated on each MD cartridge.

Stereo LP 2 (LP2) :

The recording time, available in stereo, becomes twice the figure indicated on each MD cartridge.

Stereo LP4 (LP4) :

The recording time, available in stereo, becomes four times the figure indicated on each MD cartridge.

Stamping (STAMP)

This system has a stamping function, which attaches stamp "LP:" at the beginning of each track title to facilitate identification of tracks recorded in the LP2 or LP4 mode.

"LP:" is displayed as part of a title only when a track recorded in stereo LP mode is played on a MDLP-incompatible MD recorder/player.



- A track recorded in the LP2 or LP4 mode using the MD recorder of this system can be played back on any MDLP-compatible MD recorder/player. However, if such a track is played on an MDLP-incompatible MD recorder/player, the track is played back without audio. If it is recorded using the stamping function, "LP:" is displayed at the beginning of the displayed track title.
- In stereo recording of MD, the recorded audio quality is degraded as the recording time per disc is increased. If you want to record audio with priority given to audio quality, it is recommended to use the SP mode.

Setting the recording mode

The MD recording mode can be set in stop mode.

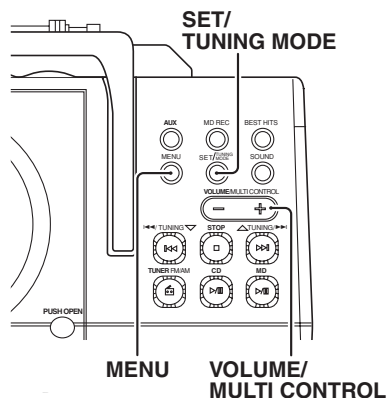

Main unit only

1 Press the **MENU** key.

2 Press the **VOLUME/MULTI CONTROL** keys to select “MD REC MODE”, then press the **SET/TUNING MODE** key.

The currently set recording mode is indicated.



3 Press the **VOLUME/MULTI CONTROL** keys to select the desired recording mode.



Display when LP2 is selected

- “SP” : Stereo recording mode (“SP” lit)
- “LP2” : Stereo LP2 mode (“LP2” lit)
- “LP4” : Stereo LP4 mode (“LP4” lit)

4 Press the **SET/TUNING MODE** key.

The setting operation is complete if you select “SP” from the above.

If you select “LP2” or “LP4”, the stamping setting screen will be displayed. In this case, go to step **5**.

5 Press the **VOLUME/MULTI CONTROL** keys to select “LP:STAMP on” or “LP:STAMP off”, then press the **SET/TUNING MODE** key.

Select “on” when you want to display “LP:” at the beginning of the track title. Select “off” if you do not want to display it.

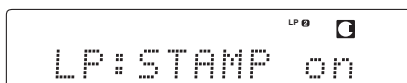

Display when “LP:STAMP on” is selected

High-speed recording of all CD tracks onto an MD

All of the tracks in a CD can be recorded in half the usual period of time. If the program play or random play mode is activated, cancel it before proceeding.

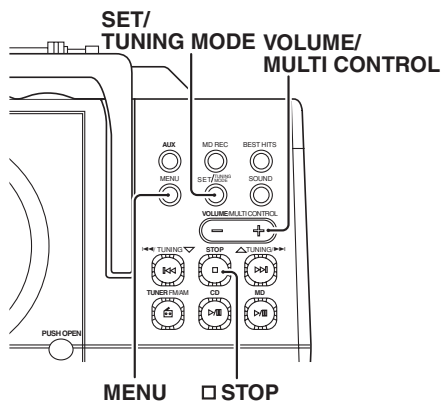
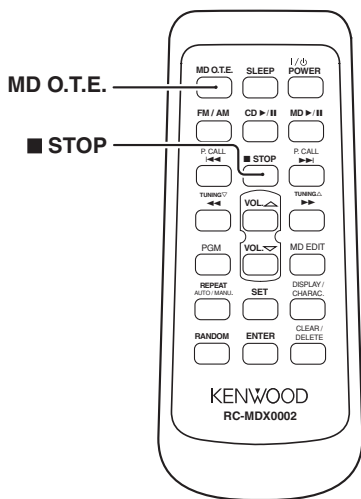

1 Make preparation for recording.

See steps 1 to 3 in "Recording CD onto MD" (page 16).

2 Press the MENU key.

3 Press the VOLUME/MULTI CONTROL keys so that "REC SPEED ?" is displayed, then press the SET/TUNING MODE key.

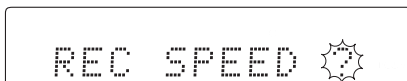

4 Press the VOLUME/MULTI CONTROL keys so that "CD→MD HIGH" is displayed, then press the SET/TUNING MODE key.

"HIGH-SPEED" lit



Select "CD→MD NORM" if you want to record CD in the normal speed.

5 Press the MD O.T.E. key on the remote.

When you are operating the main unit, see step 4 of "Recording CD onto MD" (page 17).

The CD and MD stop automatically when all the CD tracks have been recorded onto the MD.

Continued on next page →

High-speed recording of the CD track being played (Single-track recording)

- (1) Perform the operations in steps 1 to 4 (page 27).
- (2) Play the CD track to be recorded.
- (3) Press the MD O.T.E. key on the remote.

When you are operating the main unit, see step 4 of "Recording CD onto MD" (page 17).

Recording starts after returning to the beginning of the current track.

To stop recording in the middle :

Press the ■STOP key.

POINT

- Be careful not to switch the power off or apply shock or vibrations to the system while "MD WRITING" is displayed.
- Once high-speed recording is completed, it is not permitted to record the same CD by high-speed recording within 74 minutes after the start of previous high-speed recording. In case this restriction is applied, the display shows the time until the next high-speed recording becomes possible.

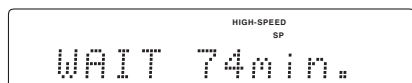

Time until re-recording is available

It is also prohibited to continue high-speed of more than 81 tracks within 74 minutes.

- If you want to record the same CD again in less than 74 minutes, set "REC SPEED" to "CD→MD NORM" and perform the MD O.T.E. recording (pages 16 to 17).

Recording onto MD

Desired music source can be recorded onto MDs.

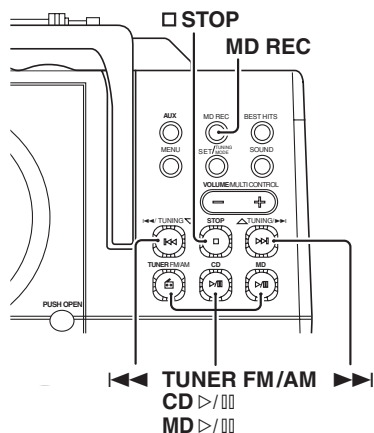

Main unit only

1 Insert a recordable MD.

2 Select the music source to be recorded.

CD : Press the CD \triangleright/\square key.

Radio : Press the TUNER FM/AM key.

AUX : Press the AUX key.

If a CD has already been loaded in advance, it starts playing automatically. Press the \square STOP key to stop it.

3 Press the MD REC key.

The unit enters record-pause mode.

Display in MD record-pause mode

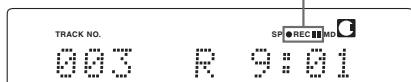

4 When the recording source is ready for playback, press the MD REC key again.

5 Play the recording source.

To stop recording :

Press the \square STOP key.

To let recording pause :

Press the MD \triangleright/\square key during recording. Press the MD \triangleright/\square or MD REC key to resume recording from the pause.

In case a message is displayed and recording will not start :

See "Display message list" (pages 56).

Tips for recording CD onto MD

When the MD recorder is in record-pause mode, recording starts automatically at the same time as the playback of CD starts. (Sync recording)

- (1) Put the CD player in play-pause mode.
- (2) Press the \lll or \ggg key to select the CD track to be recorded.
- (3) Press the MD REC key to put the MD recorder in record-pause mode.
- (4) Press the CD \triangleright/\square key to start playing the CD.

POINT

- Be careful not to switch the power off or apply shock or vibrations to the system while "MD WRITING" is displayed.
- The MD cannot be inserted or ejected while in STANDBY mode (page 59). Forcing an MD to be inserted or ejected may result in damage.
- When the CD output is recorded onto an MD, the digital signal is recorded automatically. When the radio or AUX output is recorded onto an MD, the analog signal is selected automatically.
- When recording with high volume, sound skip may occur during MD playback. To avoid this problem, reduce the volume during recording.

Continued on next page \rightarrow

With regards to track numbers at the time of recording

MD track numbers are used to search the beginning of a track or programming tracks.

- In MD recording from the radio, AUX or CD source, track numbers are assigned automatically in the following cases.
 - When the MD ►/II or MD REC key is pressed in record-pause mode to resume recording.
 - When the MD EDIT key on the remote is pressed during recording.

Recording CD tracks onto MD in desired sequence

The tracks in a CD can be recorded by rearranging them in the desired sequence when the recording speed is normal (CD→MD NORM). Note that this function is not available when the recording speed is high (CD→MD HIGH).

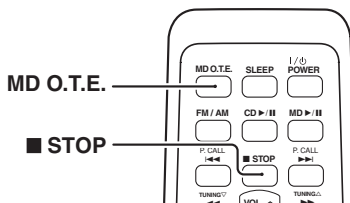

Remote control unit only

1 Make preparation for recording.

MD : See steps 1 to 3 of “Recording CD onto MD” (page 16).

2 Program the CD tracks in the desired sequence.

See steps 1 to 5 of “Playing CD or MD tracks in the desired sequence” (page 23).

3 Start recording.

Recording onto MD : Press the MD O.T.E. key.

To stop recording :

Press the ■STOP key.

POINT

- Be careful not to switch the power off or apply shock or vibrations to the system while “MD WRITING” is displayed.
- When recording with high volume, sound skip may occur during MD playback. To avoid this problem, reduce the volume during recording.

Recording only the first track of CD (BEST HITS)

Only the first track of each CD can be recorded. This function is convenient for recording the first tracks of multiple single CDs on a single MD.

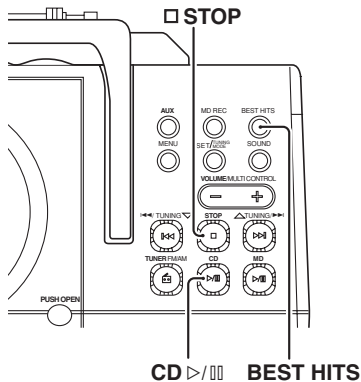

Main unit only

1 Make preparation for recording.

See steps 1 to 3 in "Recording CD onto MD" (page 16).

2 Press the CD > / ||| key.

3 Press the □STOP key.

If "PGM" is lit, switch it off by pressing the PGM key on the remote.

4 Press the BEST HITS key.

"BEST HITS," lit



(CD Display)

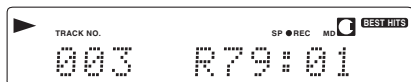

(MD Display)

When the first track of the CD has been recorded, both the CD and MD stop automatically.

5 Replace the CD and press the BEST HITS key.

Record the first tracks of other CDs by repeating this step.

To stop recording :

Press the □STOP key.

POINT

- Be careful not to switch the power off or apply shock or vibrations to the system while "MD WRITING" is displayed.
- High-speed recording can also be used in BEST HITS recording (page 27 to 28).
- When recording with high volume, sound skip may occur during MD playback. To avoid this problem, reduce the volume during recording.

Editing the MD titles

Assigning a title to a disc or track

When titles are assigned to a disc and its tracks, the titles will be displayed during play-back.

If the program play mode is activated, cancel it before proceeding.

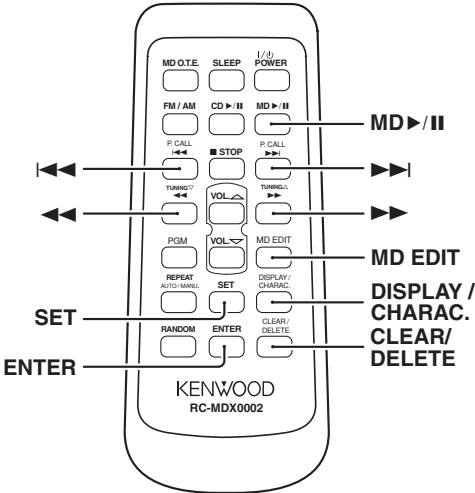

Remote control unit only

- 1** Load a prerecorded MD and select the MD input by pressing MD >|| key.
- 2** Press the MD EDIT key and press <<< or >>> key to select "TITLE INPUT", then press the SET key.
- 3** Press the <<< or >>> key repeatedly until "DISC" or the track number to be titled ("001", etc.) is displayed.

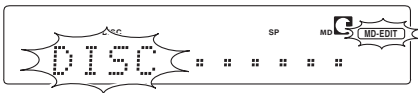

- 4** Press the SET key.
- 5** Press the DISPLAY/CHARAC. key repeatedly to select the desired character group.

Uppercase alphabet group: ABCD...
Lowercase alphabet group: abcd...
Numerical and symbol group: 0123...
For characters that can be used in titles, see "Title editing character list" (page 34).

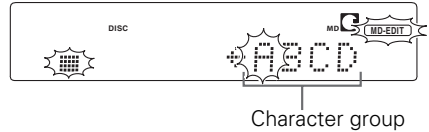

- 6** Press the <<< or >>> key repeatedly until the desired character is displayed.

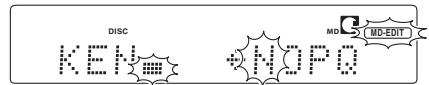

- 7** Press the SET key to enter the selected character in memory.

Compose the desired title by repeating steps 5 to 7 for each character.

Pressing the CLEAR/DELETE key clears the character located immediately before the cursor.

- 8** After composing the title, press the ENTER key.

The input title is displayed by scrolling. To assign other track titles, repeat steps 3 to 8 for each.

- 9** Press the MD EDIT key.

10 Press the \triangle **EJECT** key on the main unit to eject the MD.

"MD WRITING" is displayed.

To stop title input in the middle :

Press the MD EDIT key any time before the end of step **3**. Editing can also be canceled provided that it is attempted before "MD WRITING" is displayed. For the procedure, see "Canceling editing" (page 42).

Changing a title

- (1) Perform steps **1** to **4** of "Assigning a title to a disc or track" (page 32).
- (2) Press the \blacktriangleleft or \blacktriangleright key repeatedly to select the character to be changed.
- (3) Press the CLEAR/DELETE key to clear the character to be changed.
- (4) Perform steps **5** to **10** of "Assigning a title to a disc or track" (page 32).

Deleting a title

- (1) Perform steps **1** to **4** of "Assigning a title to a disc or track" (page 32).
- (2) Press the CLEAR/DELETE key to delete the title characters.

All of the titles can be deleted at once by selecting "ALL ERASE" in step **3** of "Assigning a title to a disc or track" (page 32).

POINT.

- Be careful not to switch the power off or apply shock or vibrations to the system while "MD WRITING" is displayed.
- If the character to be changed is not displayed, press the \blacktriangleleft or \blacktriangleright key to move the cursor and display the previously hidden characters.
- If you want to input a track title while listening to it, play the track to be titled before performing step **2** in "Assigning a title to a disc or track" (page 34).
- The number of characters that can be input is 1792 characters per disc or 80 characters per track title (including "LP:").

Title editing character list

The following characters include uppercase and lowercase alphabets, numerals and symbols.

Available characters in title input using the ►► or ◀◀ key on the remote control.

Uppercase alphabet group	ABCDEFGHIJKLMNOPQRSTUVWXYZ space
Lowercase alphabet group	abcdefghijklmnopqrstuvwxyz space
Numeral and symbol group	0123456789 space ! " # \$ % & ' () * + , - . / : ; < = > ` ? @ space_

Moving several tracks at a time

Use the following procedure to select up to 32 tracks you want to move in the desired sequence and move them together. The track numbers are adjusted automatically.

Image of moving several tracks

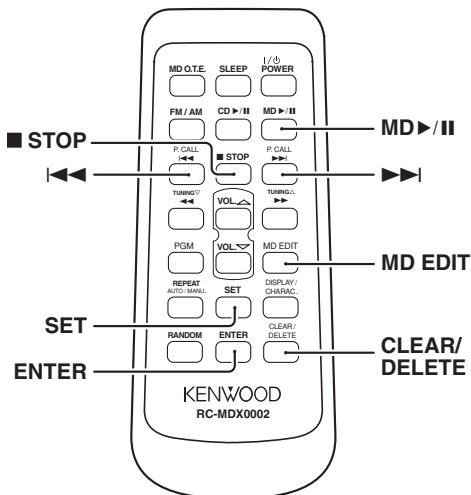
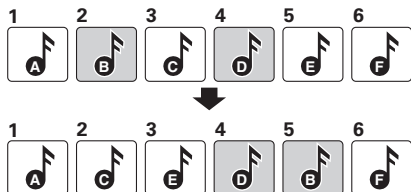

Remote control unit only

- 1** Load a prerecorded MD and select the MD input by pressing MD >|| key.

If the MD is already playing, press the ■STOP key to stop playback.

- 2** Press the MD EDIT key and press |◀◀ or ▶▶| key to select "TRACK EDIT", then press the SET key. Press |◀◀ or ▶▶| key to select "► Q. MOVE?", then press the SET key again.



- 3** Press the |◀◀ or ▶▶| key repeatedly to select one of the track numbers to be moved, then press the SET key.

Select other track numbers in the desired sequence by repeating this step for each track.

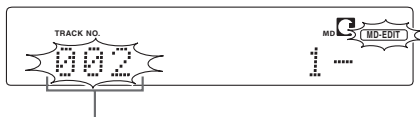

Track number to be moved

If you make a mistake, press the CLEAR/DELETE key to clear the track number and restart selection sequence by repeating this step for each track.

- 4** After selecting the desired tracks in the desired sequence, press the ENTER key.

Continued on next page →

POINT

- Be careful not to switch the power off or apply shock or vibrations to the system while "MD WRITING" is displayed.

- 5** Press the **◀◀** or **▶▶** key repeatedly to select the destination position where you want to insert the moved tracks, then press the **SET** key.

Display when 3 tracks are inserted between tracks 33 and 34.



Number of selected tracks to be moved

- 6** Press the **ENTER** key.



- 7** Press the **EJECT** key on the main unit to eject the MD.

"MD WRITING" is displayed.

To cancel the Q. MOVE operation in the middle :

Press the MD EDIT key any time before the end of step **5**.

Editing can be canceled provided that it is attempted before "MD WRITING" is displayed. For the procedure, see "Canceling editing" (page 42).

Combining tracks

Use the following procedure to combine two tracks into a single track. The track numbers after combining the tracks are adjusted automatically.

Image of combining tracks

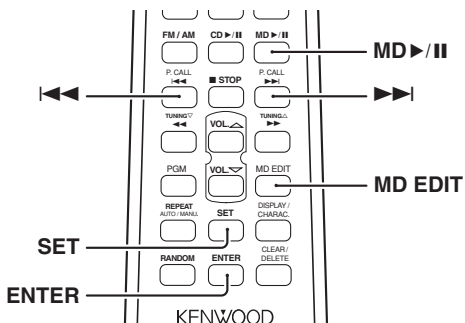

Remote control unit only

1 Load a prerecorded MD and select the MD input by pressing MD > || key.

2 Press the <<< or >>> key repeatedly to select the earlier track number to be combined.

The track will be played back.

3 Press the MD EDIT key and press <<< or >>> key to select "TRACK EDIT", then press the SET key.

Press <<< or >>> key to select "▶ COMBINE ?", then press the SET key again.



4 Press the <<< or >>> key repeatedly to select the later track number that you want to combine with the track selected above, and press the SET key.



Track number selected in step 2

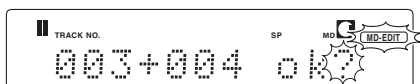

5 Press the ENTER key.

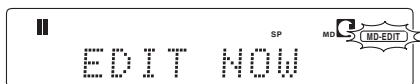

6 Press the EJECT key on the main unit to eject the MD.

"MD WRITING" is displayed.

Continued on next page →

To cancel the *COMBINE* operation in the middle:

Press the MD EDIT key any time before the end of step **4**.

Editing can be canceled provided that it is attempted before “MD WRITING” is displayed. For the procedure, see “Canceling editing” (page 42).

POINT

- Be careful not to switch the power off or apply shock or vibrations to the system while “MD WRITING” is displayed.
- Tracks recorded using different recording modes (pages 25) cannot be combined. Combination of tracks may also be inhibited by certain restrictions imposed by the MD standard.
- When the tracks are combined, the MD recorder enters pause mode at the beginning of the track created by combining.

Dividing a track

Use the following procedure to divide a track into two. The track numbers are adjusted automatically.

Image of dividing a track

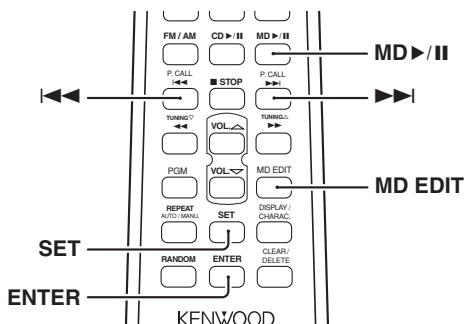

Remote control unit only

1 Load a prerecorded MD and select the MD input by pressing MD >|| key.

2 Press the <<< or >>> key repeatedly to select the track number to be divided.

The track will be played back.

3 To find the dividing point, press the MD EDIT key and press <<< or >>> key to select "TRACK EDIT", then press the SET key.

Press <<< or >>> key to select "▶ DIVIDE?".

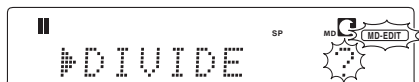

4 Press the SET key again.

5 Press the <<< or >>> key repeatedly to select the point where you want to divide the track, and press the SET key.

The audio of the 2 seconds around it will be played repeatedly.

Adjust while listening to the repeated audio.

The dividing point can be adjusted in the range between -31 and +31.

The dividing point



Point display

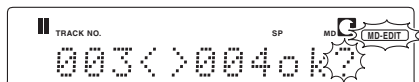

If you want to divide the track at another point, press MD EDIT key to cancel the DIVIDE operation then restart the procedure from step 2.

6 Press the ENTER key.

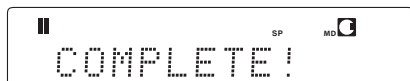
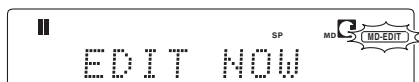

Continued on next page →

7 Press the \triangle EJECT key on the main unit to eject the MD.

“MD WRITING” is displayed.

To cancel the DIVIDE operation in the middle :

Press the MD EDIT key any time before the end of step **5**.

Editing can be canceled provided that it is attempted before “MD WRITING” is displayed. For the procedure, see “Canceling editing” (page 42).

POINT

- Be careful not to switch the power off or apply shock or vibrations to the system while “MD WRITING” is displayed.
- The track created by division does not contain no-sound section between them.
- Division of a track may be inhibited by certain restrictions imposed by the MD standard.
- When the track is divided, the MD recorded enters pause mode at the beginning of the track with the earlier track number.

Erasing several tracks at a time

Use the following procedure to select up to 32 tracks you want to erase and erase them together. The track numbers are adjusted automatically.

Image of erasing several tracks

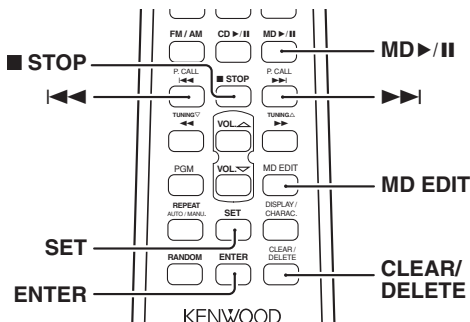
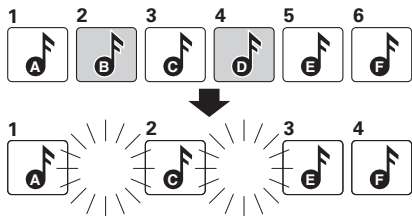

Remote control unit only

1 Load a prerecorded MD and select the MD input by pressing MD > / II key.

If the MD is already playing, press the ■STOP key to stop playback.

2 Press the MD EDIT key and press |◀◀ or ▶▶| key to select "TRACK EDIT", then press the SET key.

Press |◀◀ or ▶▶| key to select "Q. ERASE?", then press the SET key again.

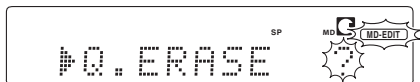

3 Press the |◀◀ or ▶▶| key repeatedly to select the track number to be erased, and press the SET key.

Select other tracks to be erased by repeating this step for each track.

Select "ALL ERASE" if you want to erase all tracks in an MD.

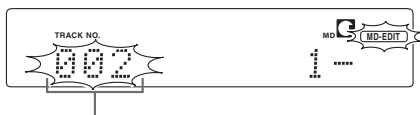

Track number to be erased
If you make a mistake, press the CLEAR/DELETE key to clear the track number and restart selection.

4 After selecting all of the tracks to be erased, press the ENTER key.



5 Press the ENTER key again.

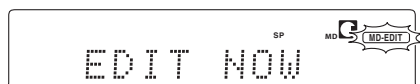

Continued on next page →

6 Press the \triangle EJECT key on the main unit to eject the MD.

"MD WRITING" is displayed.

To cancel the Q. ERASE operation in the middle:

Press the MD EDIT key any time before the end of step **4**.

Editing can be canceled provided that it is attempted before "MD WRITING" is displayed. For the procedure, see "Canceling editing".

POINT

- Be careful not to switch the power off or apply shock or vibrations to the system while "MD WRITING" is displayed.

Canceling editing

Editing can be canceled provided that it is attempted before "MD WRITING" is displayed.

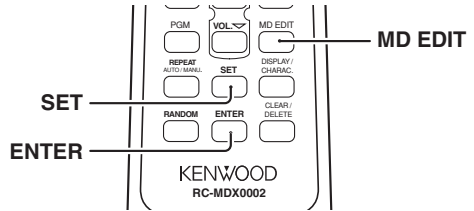

Remote control unit only

- 1** While the MD is in stop mode, press the MD EDIT key and press \lll or \ggg key to select "TRACK EDIT", then press the SET key. Press \lll or \ggg key to select "▶ CANCEL?", then press the SET key again.



Display when there is an editing to be canceled.



Display when there is no previous editing performed and nothing to be canceled.

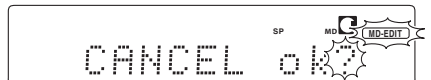

Display to confirm the cancellation.

- 2** Press the ENTER key.

To cancel the CANCEL operation in the middle :

Press the MD EDIT key any time before the end of step **1**.

Waking up to the timer playback (O.T.T.)

The O.T.T. makes timer-activate playback possible by simply setting the desired time of the day. The system is automatically turned off in 1 hour after the start of timer playback. The O.T.T. timer works only once after it has been set

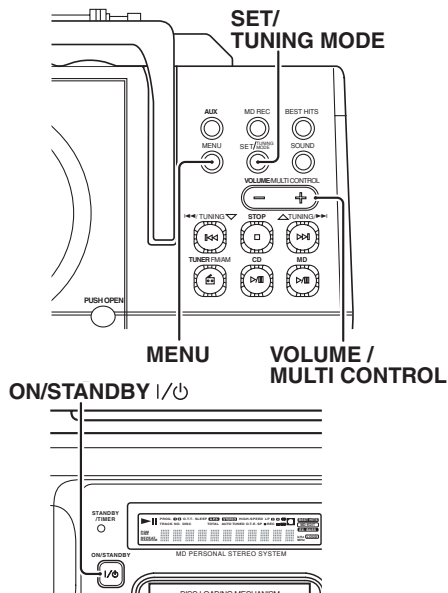

■ Setting

- 1 Press the **MENU** key.
- 2 Press the **VOLUME/MULTI CONTROL** keys so that "TIMER SET?" is displayed, then press the **SET/TUNING MODE** key.

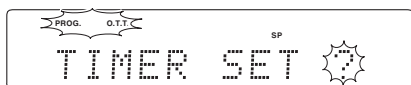

- 3 Press the **VOLUME/MULTI CONTROL** keys so that "O.T.T. ON?" is displayed, then press the **SET/TUNING MODE** key.

"O.T.T." blinking

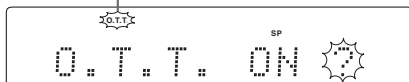

- 4 Press the **VOLUME/MULTI CONTROL** keys to select the time at which the timer is activated (ON time).

The ON time can be set in 5-minute steps.

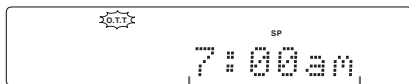

ON time display

- 5 Press the **SET/TUNING MODE** key.

■ Execution

- 6 Make preparations according to the source to be played.

CD : Load a CD.

MD : Load an MD.



Radio : Receive the station to be played.

AUX component : Make the required preparation for playback by connecting an AUX component.

Continued on next page →

7 *Press the **VOLUME/ MULTI CONTROL** keys to adjust the listening volume.*

The source will be played at the adjusted volume.

8 *Press the **ON/STANDBY** | /  key (or | /  **POWER** key on the remote control) to switch the power off to the **STANDBY** mode.*

The STANDBY/TIMER indicator lights green.

The O.T.T. timer is activated and playback will start when the set ON time comes.

To cancel O.T.T. timer :

Perform steps **7** to **8** and select "TIMER OFF" and "O.T.T." will disappear.

To check or change the timer setting :

Restart the procedure from step **7** again.

P O I N T .

- Be sure to adjust the time of the day (page 7) before using the timer functions.
- When the STANDBY/TIMER indicator is blinking in green, the timer setting or clock setting is erroneous. Check and correct them as required (pages 7 & 43 to 44).
- The O.T.T. timer cannot be used for program playback of CD or MD.
- Even when the O.T.T. timer is canceled, previously made setting is stored in memory and remains until new timer information is set the next time.

Program timer

The program timer can store the timer operating hours and its contents so the timer operation can be activated or deactivated as required at any time. The program timer can be activated on any time.

Timer playback using program timer

Use the following procedure to play the selected source at the selected time period.

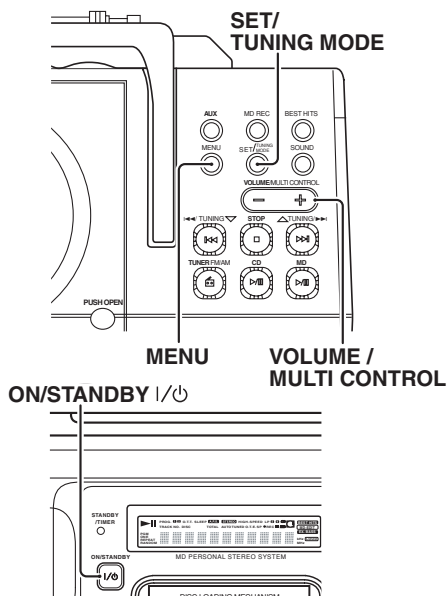

Setting

1 Make preparations according to the source to be played.

- CD : Load a CD.
- MD : Load an MD.
- Radio : Preset stations (page 8 and 9).
- AUX component : Make the required preparation for playback by connecting an AUX component.

Be sure to set the timer for the AUX source component connected to the AUX IN jacks.

2 Press the MENU key.

3 Press the VOLUME/MULTI CONTROL keys so that "TIMER SET?" is displayed, then press the SET/TUNING MODE key.

4 Press the VOLUME/MULTI CONTROL keys so that "PROG. ON" is displayed, then press the SET/TUNING MODE key.

"PROG." blinks

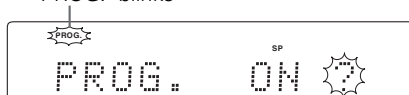

5 Select the time to start timer playback (ON time).

Press the VOLUME/MULTI CONTROL keys to select the figure of hour, then press the SET/TUNING MODE key.

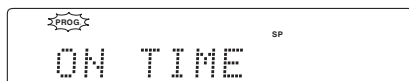

Timer ON time

Also select the figure of minute in the same way as above.

Continued on next page →

6 **Select the time to stop timer playback (OFF time).**

Set in the same way as the ON time.



Timer OFF time

7 **Press the VOLUME/MULTI CONTROL keys to select "PLAY" or "AI PLAY", then press the SET/TUNING MODE key.**

"PLAY" : The source will be played at the adjusted volume before entering the STANDBY mode.

"AI PLAY" : The listening volume increases gradually from the start of timer playback until it reaches a certain level.

Display when "PLAY" is selected

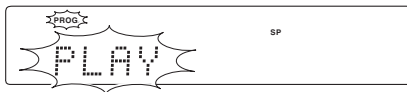

8 **Press the VOLUME/MULTI CONTROL keys to select the music source to be input, then press the SET/TUNING MODE key.**

The input source can be selected from "CD", "MD", "AUX" (AUX component) and "TUNER" (radio).

9 **To listen to radio broadcasting, press the VOLUME/MULTI CONTROL keys to select the preset number of the desired station, then press the SET/TUNING MODE key.**

This operation is not required when an input source other than "TUNER" is selected.

10 **Press the VOLUME/MULTI CONTROL keys to adjust the listening volume.**

The source will be played at the adjusted volume.

This step is not required when "AI PLAY" is selected.

■ **Execution**

11 **Press the ON/STANDBY | / ⏻ key (or | / ⏻ POWER key on the remote control) to put the unit in the STANDBY mode.**

The STANDBY/TIMER indicator lights in green.

When the set ON time comes, the timer program is executed and playback starts.

To cancel program timer :

Perform steps **2** to **4** and select "TIMER OFF" of "Program timer" (page 45) until "PROG." is not lit.

To check or change the timer setting :

Restart the procedure from step **1** again.

POINT

- Be sure to adjust the time of the day (page 7) before using the timer functions.
- The program timer cannot be used for program playback of CD or MD.
- Even when the program timer is canceled, previously made setting is stored in memory and remains until new timer information is set the next time.
- When the STANDBY/TIMER indicator is blinking in green, the timer setting or clock setting is erroneous. Check and correct them as required (pages 7 & 45 to 46).

Timer recording using program timer

The audio of TUNER (radio) or AUX started by the timer playback at the set time can be recorded onto an MD during timer playback.

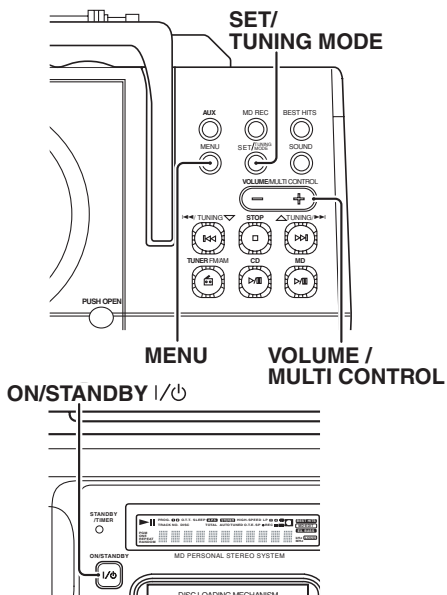

■ Setting

1 Make preparation for recording.

MD : See steps **1** to **3** in "Recording CD onto MD" (page 16).

2 Perform steps **2** to **6** of "Timer playback using program timer" (page 45 to 46).

3 Press the VOLUME/MULTI CONTROL keys to select "REC", then press the SET/TUNING MODE key.



Continued on next page →

4 Press the **VOLUME/MULTI CONTROL** keys to select **"TUNER"** or **"AUX"**, then press the **SET/TUNING MODE** key.

"TUNER": Radio

"AUX" : AUX input source

5 To record a radio station, press the **VOLUME/MULTI CONTROL** keys to select preset station to be recorded, then press the **SET/TUNING MODE** key.

POINT

- Be sure to adjust the time of the day (page 7) before using the timer functions.
- The speakers' output will decrease during timer recording.
- Even when the program timer is canceled, previously made setting is stored in memory and remains until new timer information is set the next time.
- When the STANDBY/TIMER indicator is blinking in green, the timer setting or clock setting is erroneous. Check and correct them as required (pages 7 & 47 to 48).

■ Execution

6 Press the **ON/STANDBY** | **⏻** key (or **⏻** **POWER** key on the remote control) to put the unit in the **STANDBY** mode.

The STANDBY/TIMER indicator lights in green.

When the set ON time comes, the timer program is executed and recording starts.

To cancel program timer :

Perform steps **2** to **4** and select "TIMER OFF" of "Program timer" (page 45) until "PROG." is not lit.

To check or change the timer setting :

Restart the procedure from step **1** again.

Sleep timer (SLEEP)

When the time set for the SLEEP time has elapsed, the system is turned off automatically. The time until the system is turned off can be selected in 10-minute steps up to 90 minutes.

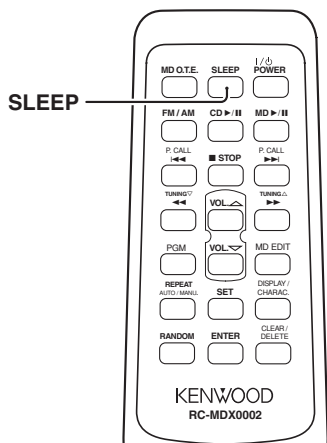

Remote control unit only

Press the SLEEP key repeatedly until the desired OFF time.

10 minutes increment is adjustable by each press.

10 → 20 ... 80 → 90 → cancel → 10 ...
"SLEEP" lit

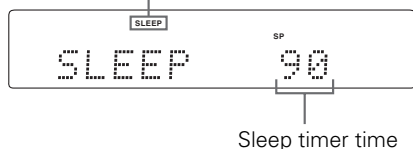

To check the remaining sleep timer :

Press the SLEEP key during execution of the sleep timer.

To cancel sleep timer :

Press the SLEEP key repeatedly so that "SLEEP" disappears.

Auto power save (A.P.S.)

The system can be set up so that it turns off automatically when it has been left for more than 30 minutes with all of its CD player and MD recorder in stop mode or with its volume set to "0" while the selected input is "TUNER" or "AUX". This facility is convenient if you forget to switch the system power OFF.

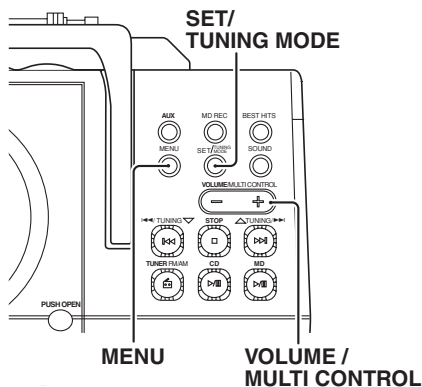

Main unit only

- 1 Press the MENU key.
- 2 Press the VOLUME/MULTI CONTROL keys so that "A.P.S. SET?" is displayed, then press the SET/TUNING MODE key.

"A.P.S." blinking

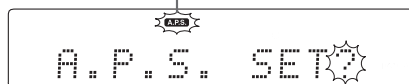

- 3 Press the VOLUME/MULTI CONTROL keys to select "ON" (activated) or "OFF" (deactivated), then press the SET/TUNING MODE key.

Display when "ON" is selected

"A.P.S." lit



Important items

Caution on condensation

Condensation (of dew) may occur inside the unit when there is a great difference in temperature between this unit and the outside. This unit may not function properly if condensation occurs. In this case, leave the unit for a few hours and restart the operation after the condensation has dried up.

Be specially cautious against condensation in the following circumstances:

When this unit is carried from one place to another across a large difference in temperature, when the humidity in the room where this unit is installed increases, etc.

Note related to transportation and movement

Before transporting or moving this unit, carry out the following operations.

- (1) Remove the CD or MD from the unit.
- (2) Press the ►/|| key of the MD.
- (3) Wait for some time and verify that the display becomes as shown in the figure.

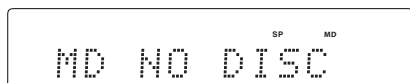

- (4) Press the ►/|| key of the CD.
- (5) Wait for some time and verify that the display becomes as shown in the figure.

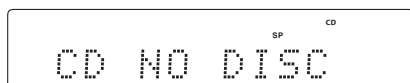

- (6) Wait a few seconds and turn the unit OFF.

Disc handling precautions

Handling

Hold the disc so that you do not touch the playing surface.

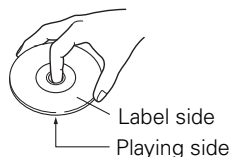

Do not attach paper or tape to either the playing side or the label side of the disc.

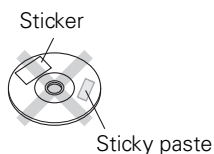

Cleaning

If there are fingerprint marks or foreign matter found on the disc, lightly wipe the disc with a soft cotton cloth (or similar) from the center of the disc outwards in a radial manner.

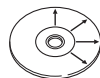

Storage

When a disc is not to be played for a long period of time, remove it from the player and store it in its case.

Discs which can be played with this unit

CD (12 cm, 8 cm) and the audio part of CDV, CD-G, CD-EG and CD-EXTRA. Use discs that comply with the IEC standard, for example a disc carrying the  marking on the label surface.

Important items(continued)

Never play a cracked or warped disc

During playback, the disc rotates at high speed in the player. Therefore, to avoid danger, never use a cracked or deformed disc or a disc repaired with tape or adhesive agent. Please do not use discs which are not round because they may cause malfunction.

Disc accessories

The disc accessories (stabilizer, protection sheet, protection ring, etc.) which are marketed for improving the sound quality or protecting discs as well as the disc cleaner should not be used with this system because they may cause malfunction.

Handling of MD

As the MD is accommodated inside a cartridge, it can be handled without caring about dust or fingerprint. However, stained or soiled cartridge may cause malfunction. To enjoy beautiful sound for extended period of time, take care on the following points.

Do not touch the disc directly.

Do not touch the disc by opening the shutter with your hand. The cartridge will be damaged if it is forced open.

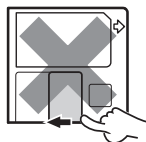

Storage position

Do not leave MDs in places where the temperature and/or humidity are extremely high (for example, in places subjected to direct sunlight).

Dust countermeasure

The shutter of the disc cartridge is permanently open while the disc is loaded in the set. Therefore, to prevent dust from penetrating inside the disc, take the disc out of the unit immediately after completion of recording or playback.

Care

Periodically wipe off dust and dirt on the cartridge with a dry cloth.

Note on disc accessories

Do not use lens cleaner for this may lead to malfunction of the unit.

Write protect tab

To protect recorded contents against accidental erasure, set the write protect tab of the disc open. Return the tab to the original position when you want to record signals on the disc.

Back side of the disc

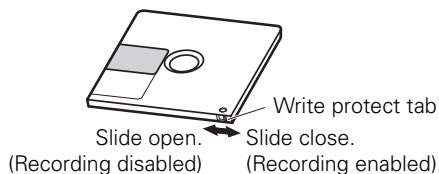

Note on the cartridge labels

Apply each label firmly to every corner so that it will not be peel off.

Caution on MD-Clip data

Do not attempt to record or edit a disc in which MD-Clip data (still images, etc.) have been recorded. Otherwise, the Clip data may be lost.

Continued on next page →

Important items(continued)

Maintenance of the unit

When the front panel or case becomes dirty, wipe with a soft, dry cloth. Do not use thinner, benzine, alcohol, etc. for these agents may cause discoloration.

In regard to contact cleaner

Do not use contact cleaners because it could cause a malfunction. Be specially careful not to use contact cleaners containing oil, for they may deform the plastic component.

Memory backup function

Stored contents which are cleared immediately when power plug is unplugged from power outlet.

- Clock display (Backed up for 3 min.)

Stored contents which are cleared in at least a day after power plug is unplugged from power outlet.

- **Amplifier section**

- Input selection
- Volume control value
- AUX input level
- Tone control levels
- Timer setting contents

- **Tuner section**

- Receiving band
- Frequency
- Preset stations
- Auto tuning setting

- **MD recorder**

- Recording mode
- Recording speed

WARNING NOTICE:

In most cases it is an infringement of copyright to make copies of tapes or discs without the permission of the copyright owners. Anyone wishing to copy commercially available tapes or disc should contact the mechanical copyright protection society limited or the performing rights society limited.

US and foreign patents licensed from Dolby Laboratories.

In case of difficulty

What seems to be a malfunction is not always so. Before calling for service, check the following table according to the symptom of your trouble.

Operation to reset

The microcomputer may fall into malfunction when a cord is unplugged and plugged again while the unit is ON or due to an external cause. In such a case, the microcomputer should be reset as described below:

Unplug the power cord from the wall outlet and, while holding the ON/STANDBY I/⏻ key depressed, plug the power cord again. This initializes the microcomputer. Note that this clears the previously stored memory.

Common section

Sound is not produced.

- ➔ Increase the volume level. (page 11)
 - ➔ Unplug the headphones if they are connected. (page 6)
-

No sound from the headphones.

- ➔ Check if the headphone plug is inserted properly into the jack. (page 6)
-

Noise interferes.

- ➔ Install the outside antenna more apart from the streets. (page 5)
 - ➔ Turn nearby electrical appliances off.
 - ➔ Install the audio system more apart from the TV set or personal computer.
-

Amplifier / Speaker section

The clock display blinks without changing the figures.

- ➔ Adjust the present time again. (page 7)
-

Timer operation is not possible.

- ➔ If the present time has not been adjusted or there was a power failure, adjust the present time. (page 7)
 - ➔ Set the timer ON time and OFF time. (pages 43 to 46)
-

Radio stations cannot be received.

- ➔ Connect the provided AM loop antenna to the AM ANTENNA jack. (page 5)
 - ➔ Extend the FM rod antenna and orient it to the direction in which best reception is obtained. (page 5)
 - ➔ Select the correct broadcast band. (pages 8 to 9)
 - ➔ Tune to the frequency of the desired station. (page 9)
-

After a radio station is preset, it cannot be received by pressing the ◀◀ PCALL or ▶▶ PCALL button.

- ➔ Preset stations with tunable frequencies. (pages 8 to 9)
 - ➔ If the preset memory has been cleared because the power cord has been unplugged for a long period, preset the stations again. (pages 8 to 9)
-

Continued on next page ➔

Remote control unit

Remote control operation is not possible.

- ➔ Replace batteries with new ones. (page 4)
 - ➔ If the remote is too far away from the system or there is an obstacle in between, point the remote to the remote sensor on the main unit. (page 4)
-

MD recorder section (Symptoms related to the MD standard)

The recordable time of the disc does not increase even when a short track is erased.

- ➔ The remaining recording time does not increase when the total time of the erased track(s) is less than 12 seconds.
 - ➔ When the disc has been edited several times, the remaining recordable time may not increase.
-

Tracks cannot be combined.

- ➔ When the disc has been edited several times, the tracks may be unable to be combined.
-

The total of the recorded time and remaining recordable time does not coincide with the recording time specified for the MD.

- ➔ As the minimum unit of disc recording is 2 seconds, the displayed time information may differ from the actual usage of the disc area.
-

Sound is interrupted after forward or reverse search.

- ➔ When the disc has been edited several times, the sound may be intermittent.
-

"MD READING" is displayed for an abnormally long time.

- ➔ When a new recordable MD (with nothing recorded) is inserted, "MD READING" is displayed longer than usual.
-

MD recorder section

Sound is not output even when the play key is pressed.

- ➔ Use a recorded MD.
-

Recording is not possible.

- ➔ Restore the position of the write protect tab to the write enabled position. (page 51)
 - ➔ Select the input source to be recorded. (page 29)
 - ➔ When recording with high volume, sound skip may occur during MD playback. To avoid this problem, reduce the volume during recording.
-

Recording level is too low (with the AUX input).

- ➔ Adjust the AUX INPUT level. (page 22)
-

Sound is distorted.

- ➔ The recording input level (AUX input) is not adjusted correctly.
Adjust the AUX INPUT level. (page 22)
-

CD player section

Sound is not produced even when the play key is pressed.

- ➔ Insert the CD properly. (page 10)
 - ➔ Clean the disc as described in “Disc handling precautions.” (pages 50 and 51)
 - ➔ Remove condensation as described in “Caution on condensation.” (page 50)
-

Sound skips.

- ➔ Clean the disc as described in “Disc handling precautions.” (pages 50 and 51)
 - ➔ Check that the disc is not scratched.
 - ➔ Install the unit in a place not subject to vibrations.
-

Display message list

BLANK DISC	→ No MD data is recorded.
BUFFER OVER	→ An attempt is made to perform high-speed recording of more than 81 tracks within 74 minutes.
CAN'T EDIT	→ An attempt is made to edit a track which is too short.
CD LID OPEN	→ The CD door is open.
CD NO DISC	→ An CD is not inserted.
DISC ERROR	→ The contents of UTOC* are abnormal. In this case, perform "ALL ERASE" operation (page 41). If this is not possible, use another disc.
DISC FULL	→ There is no recordable area on the disc or an attempt is made to record a 256th track. In this case, use another recordable disc. Note that more than 255 tracks cannot be recorded on a disc.
FULL	→ An attempt is made to select a 33rd track when setting the Q.ERASE or Q.MOVE operation.
MD NO DISC	→ An MD is not inserted.
MD READING	→ The TOC* information in the disc is being read.
MD WRITING	→ The data related to editing or recording is being written in the disc.
NO TRACKS	→ The MD disc does not contain any track but has a disc title.
PGM FULL	→ An attempt is made to select a 33rd track when programming CD or MD tracks.
PLAY ONLY	→ The inserted MD is a playback only disc. Insert a recordable MD.
PROTECTED	→ The inserted MD is write-protected. In this case, enable the recording. (page 51)
SCMS	→ An attempt is made to record digital signal from a source while its digital copy has been prohibited by SCMS.
TITLE FULL	→ An attempt is made to assign a title with more characters than usable.

* All minidisks contain a Table of Contents (TOC) in addition to sound signals. The TOC is similar to the table of contents in a book and contains information, such as track numbers, track length, and character information, that cannot be rewritten. In addition to the TOC, minidisks also contain a special User's Table of Contents (UTOC) that contains track number, track length, and character information, that can be rewritten.

Specifications

Amplifier section

Rated output power during STEREO operation
1 kHz, 10%, 4Ω 3.5 W + 3.5 W

Tuner section

FM tuner
Tuning frequency range
..... 87.5 MHz ~ 108 MHz
AM tuner
Tuning frequency range
..... 531 kHz ~ 1,602 kHz

MD Recorder section

Laser wave length 765 to 805 nm
Laser power class Class 3B
Laser Semiconductor laser
Recording method
..... Field modulating overwriting
Audio compression method
..... ATRAC, ATRAC3
D/A conversion 1 Bit
Wow & flutter Unmeasurable limit

CD Player section

Laser wave length 770 to 795 nm
Laser power class Class 3A
Laser Semiconductor laser
D/A conversion 1 Bit
Over sampling frequency 8 fs (352.8 kHz)
Frequency response 20 Hz to 20 kHz
Wow & flutter Unmeasurable limit

Speakers

Enclosures Bass-reflex type
Speaker units 80 mm, cone type

General

Power consumption 35 W
Dimensions W : 386 mm (16-1/8")
..... H : 146 mm (5-3/4")
..... D : 189 mm (7-7/16")
Weight (net) 5.6 kg (12.3lb)



- KENWOOD follows a policy of continuous advancements in development. For reason specifications may be changed without notice.
- The full performance may not be exhibited in an extremely cold location (under a water-freezing temperature).

Controls and indicators

Main Unit

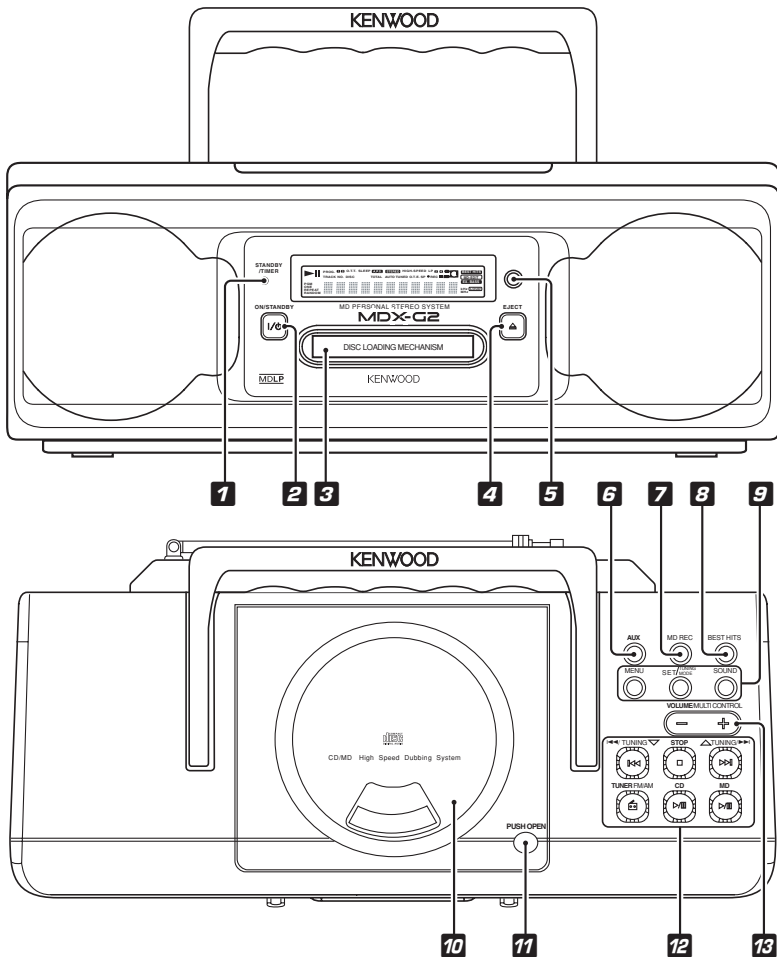

- 1** STANDBY/TIMER indicator (59)
- 2** ON/STANDBY I/O
- 3** MD insertion slot (12)
- 4** EJECT (MD ejection) (13)
- 5** REMOTE (Remote sensor) (4)
- 6** AUX (18)
- 7** MD REC (29)

- 8** BEST HITS (31)
- 9** MENU (7)
- SET/TUNING MODE (7)
- SOUND (21)
- 10** CD door (10)
- 11** PUSH OPEN (CD ejection) (10)

- 12** TUNING, STOP, TUNING (Skip) ∇, Δ TUNING (15)
- STOP (7)
- TUNER FM/AM (8)
- CD \triangleright/\square (Play/ Pause) (10)
- MD \triangleright/\square (Play/ Pause) (12)
- 13** VOLUME/MULTI CONTROL (-/+)

Figures inside parentheses are reference pages.

Standby mode

While the standby indicator of the unit is lit, a small amount of current is flowing into the unit's internal circuitry to back up the memory. This condition is referred to as the standby mode of the unit. While the unit is in standby mode, it can be switched ON from the remote control unit.

Relationship between the STANDBY/TIMER indicator and the status of unit

Indicator condition	Unit status
Off	Power is ON.
Red lighting	The power cord is plugged into a wall outlet and the power is in the STANDBY mode.
Green lighting	Timer has been activated.
Green blinking	Timer setting is erroneous, an attempt is made to set the timer without setting the time of the day, or the timer was not activated correctly due to a power failure, etc.
Red blinking	Failure in the power circuitry. Have your dealer or local KENWOOD representative inspect and service the unit.

Remote control unit

The keys on the remote control unit with the same names as on the main unit have the same function as the keys on the main unit.

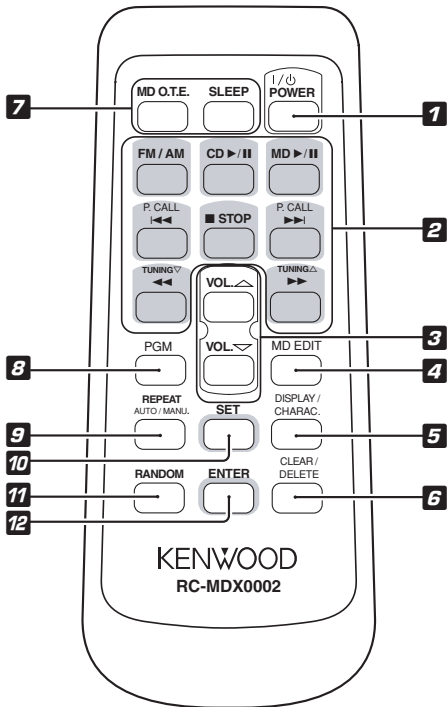

- 1** I/⏻ POWER
- 2** FM/AM (8)
CD ▶/|| (Play/ Pause) (10)
MD ▶/|| (Play/ Pause) (12)
◀◀ P. CALL ▶▶ (Skip)
■ STOP
◀◀ TUNING ▽
▶▶ TUNING △
- 3** VOLUME ▲/▼ (11)
- 4** MD EDIT (32)
- 5** DISPLAY/CHARAC. (17, 32)
- 6** CLEAR/DELETE (23, 32)
- 7** MD O.T.E. (16)
SLEEP (49)
- 8** PGM (23)
- 9** REPEAT (24), AUTO/MANU. (9)
- 10** SET (23)
- 11** RANDOM (24)
- 12** ENTER (9)

Figures inside parentheses are reference pages.

KENWOOD

For your records

Record the serial number, found on the back of the unit, in the spaces designated on the warranty card, and in the space provided below. Refer to the model and serial numbers whenever you call upon your dealer for information or service on this product.

Model _____ Serial Number _____